

2025 Lighting Collection

CATALOG 2025

LED LIGHTING SOLUTIONS & CONTROL SYSTEMS

LINEAR, STRIP, SPOT, CEILING, PANEL,
MODULAR SYSTEMS, SEG LIGHT BOX

L&S Lighting
Intelligence

NEW

LIGHT BOX

Introducing the **L&S SEG Light Box** – the ideal solution for impressive visual displays. With customizable dimensions and a range of frame depths, this premium LED backlit Light Box delivers vibrant, even illumination for your graphics.

See product details on page 88.



Linear 08

MINI TUBULAR R	10	NEW! SIRENUSE	22	MALINDI 2	34
MINI TUBULAR Q	12	NEW! VIVARA	24	MINI KENDO	36
MINI TUBULAR IC 2	14	SKYLINE	26	SNITE	38
CALI	16	MEC CORNER	28	SNITE PRO	40
MINI	18	MEC QUATTRO	30	KITON	42
MICROLINE	20	MINI NOOR	32		

LED Strips 44

STRIP REEL COB	46	LED STRIP 8MM	51	STRIP REEL RGB (COB/REGULAR)	54
LED STRIP 5MM	48	LED STRIP 10MM	52	MINI OCTOPUS	56

MEC Professional 58

MEC MALINDI	60	MEC QUATTRO	62	COUNTERTOP ILLUMINATION	65
MICRO MEC-3	61	MEC RACK	63	SLIM COVER DIFFUSER	65
MEC CORNER	62	NUBIO	64		

Spots and Ceiling 66

NUBE	68	SUPERSPOT	74	NEW! DAHLIA	78
MOONLIGHT	70	TAOS	76	NEW! SAVANNAH	80
SUPERLIGHT	72				

Light Panels and Light Box 82

SOLARIS L5, L7, LUMI, BACK, DOUBLE, SNAP-IN	85	SOLARIS CEILING	86	NEW! LIGHT BOX	88
---	----	-----------------	----	-----------------------	----

Modular Systems 90

SIGN	92	NEW! HI LINE	100	MINI TRACK 2	112
NEW! THIN LINE	96	POWERLINE	104	AVIOR	114

Power Supplies and Control Systems 116

MEC DRIVER SYSTEM	118	SMART CONTROLLERS	125	SWITCHES	128
SMART MODULES	122	SENSORS	127	ADDITIONAL DRIVERS	129

Accessories 130

QI / USB CHARGER	132	EXTENSION CORDS, DISTRIBUTION BLOCKS	133	CABLE CHANNELS, CABLES	133
------------------	-----	--------------------------------------	-----	------------------------	-----

L&S DEUTSCHLAND GMBH
RÖDINGHAUSEN, GERMANY
SINCE 2002

L&S ITALIA S.P.A.
BRUGNERA, ITALY
SINCE 1977

FORMA E FUNZIONE S.R.L.
VARESE

FLEXLITE
VENEZIA

L&S LIGHTING CORPORATION
ATLANTA, USA
SINCE 2011

5

PRODUCTION SITES AND
COMMERCIAL SITES

50+

YEARS OF EXPERIENCE

4

SPECIALIZED R&D DEPARTMENTS

50+

COUNTRIES

500+

TEAM MEMBERS

455,000

SQFT OF PRODUCTION AND SHOWROOM AREA

One international Group, serving the global market.



L&S LIGHTING EQUIPMENT
SHANGHAI, CHINA
SINCE 2006

L&S Lighting was founded in Italy in 1977 to meet the needs of the furniture industry and soon became a leading international player.

Thanks to the high quality of our production activities and constant investment in technological research, we have progressively expanded our presence in foreign markets. We have had sales offices, R&D departments

and production facilities in Germany since 2002, in China since 2006 and in the USA since 2011. Today, the Group employs over 450 people and operates in more than 50 countries.

The Italian plant covers a total area of 264,000 square foot and houses the management offices, production, logistics and sales facilities, as well as the Research & Development division.

The German office with its commercial action and focus on technology contributes to the company's expansion into the European market.

The USA, with its expertise and ingenuity, and China with its specialization in electronics and mechanics, both develop their own target markets and are a logistics hub for international customers.

We craft lighting solutions that inspire design creativity and elevate personal experiences.

Sustainable Design

We are implementing product development processes inspired by circular economy principles, partnering with universities, designers, and research centers - an investment in the future. Our focus is on enhancing the group's core products.

- **Next-generation high-efficiency LED strips:** Achieve up to 50% energy savings compared to the previous version.
- **Mec Lite platform:** Streamlines design by reducing components and minimizing size with an integrated power supply driver.
- **All-in-one sensor:** Combines three functions into a single, compact solution.
- **Smart home integration:** Enables efficient remote lighting management through smart-ready technologies.

These improvements reflect our commitment to sustainable innovation and technological efficiency.



Integration with new technologies and protocols

We have integrated advanced technologies to ensure full compatibility with smart home management systems. Choosing the right configuration is now simpler with new modules supporting Zigbee and Matter protocols.

Innovative patented solutions

Leveraging our R&D expertise and experience in integrating lighting into interiors, we collaborate with your technical teams to turn your ideas into projects, prototypes, and finished products. As your ideal partner for co-developing lighting solutions, we add value to your products. Our 10 patents showcase our dedication to innovation.

Smart Home Ecosystem

The Mec modular system makes lighting control simple and versatile. Choose from a button, a sensor with motion, infrared, and touch functions, or remote management via app, transmitter, or voice commands. Easily personalize your lighting with seamless integration into voice assistants and smartphones.

With our in-house expertise, we deliver high-quality solutions tailored to the needs of diverse users and markets.



In-house testing laboratories

We invest in advanced diagnostic and analytical tools for our in-house laboratories to ensure the safety and reliability of our products through continuous testing. Additionally, we provide comprehensive documentation for certifications and offer real-time support to stay updated on regulatory changes.

Worldwide certifications

Our products are designed for easy certification under all major market standards, speeding up time-to-market. New L&S products are built to meet current regulations without effort, anticipate future requirements, and ensure fast compliance.

Global platform for production and logistics

With locations in Europe, China, and the United States, our international presence connects us directly to key furniture manufacturing hubs. We provide a global platform for logistics, production, and service, sharing valuable expertise across regions. This gives our partners a competitive edge—whether they're already operating globally or planning to expand into international markets.

Linear



SURFACE
MOUNTED
LINEAR
FIXTURES
—



10
MINI
TUBULAR R



12
MINI
TUBULAR Q



14
MINI
TUBULAR IC 2



16
CALI



18
MINI



20
MICROLINE



NEW!
SIRENUSE

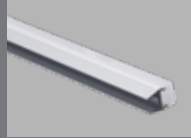

NEW!
VIVARA

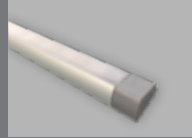

26
SKYLINE

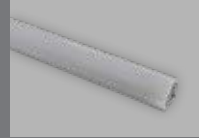

28
MEC CORNER



30
MEC QUATTRO

RECESSED
LINEAR
FIXTURES
—



32
MINI NOOR



34
MALINDI 2

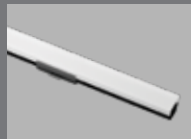

36
MINI KENDO

SPECIALTY
LINEAR
FIXTURES
—



38
SNITE



40
SNITE PRO



42
KITON

MINI TUBULAR R



Custom: 150-1500mm

The Mini Tubular R is a surface mounted linear fixture that swivels for precise aim of the beam angle. It comes with standard wood mounting clips and is also available with glass installation clips.

Product Characteristics

- Available in custom lengths 150mm-1500mm (1-5ft.)
- Available in 3000K, 4000K, and Emotion (additional color temperatures available on request)
- Change color temperature (WW to CW) with Emotion Technology
- CRI >90
- Aluminum heat sink for maximum heat dissipation
- Attached 2m (7ft.) cord 20 AWG, disconnect at 75mm (3"), 12V black, 24V white
- Daisy chain version optional
- Wood mounting kit included
- Magnetic mounting kit optional

Suitable Applications

- Retail Displays
- Casework
- Under Cabinet
- Shelving

Specifications

	160 LED/m	EMOTION 12V	EMOTION 24V
L	150-1500mm (1-5ft.)	150-1500mm (1-5ft.)	150-1500mm (1-5ft.)
Lm	1950lm/m (594lm/ft.)	1170lm/m (357lm/ft.)	1170lm/m (357lm/ft.)
W	13W/m (4W/ft.)	13W/m (4W/ft.)	13W/m (4W/ft.)
Max 18W Driver	1m (3ft.)	1.4m (5ft.)	1.4m (5ft.)
Max 36W Driver	2.1m (7ft.)	2.8m (9ft.)	2.8m (9ft.)
Max 48W Driver	2.8m (9ft.)	3.7m (12ft.)	3.7m (12ft.)
Max 60/72W Driver*	4.3m (14ft.)	4.6m* (15ft.)	5.5m (18ft.)
Max 90W Driver	5.3m (17ft.)	-	6.9m (23ft.)

* 12V lights are only compatible with drivers up to 60W max.

Photometrics

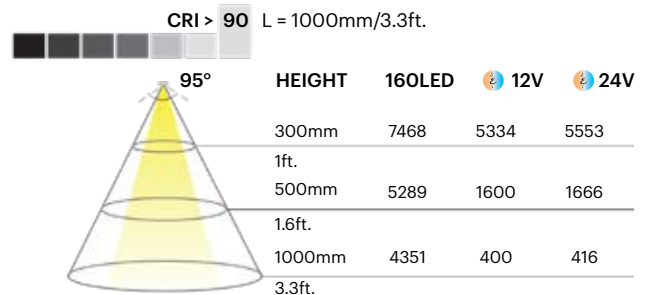

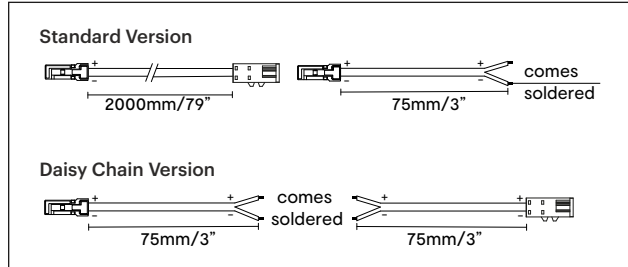
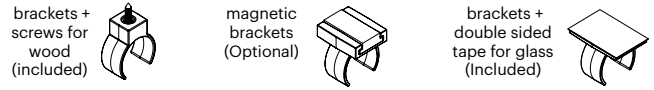
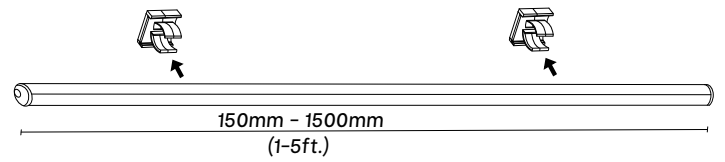
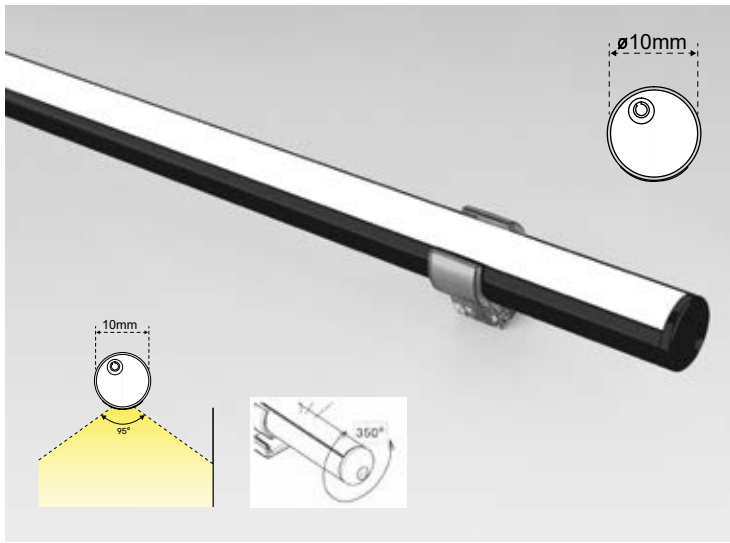

Mini Tubular R

24V / 160 LED/m

Item Code*	L (mm)	L (ft)	Wattage	Kelvin	Lumen
2003230	150-1500mm	1-5ft.	13W/m (4W/ft.)	3000K	1950lm/m (594lm/ft.)
2003240				4000K	

Additional color temperatures (CCT) are available on request. Expected lead time 4 weeks + shipping.

Mini Tubular R

12V / Emotion

Item Code*	L (mm)	L (ft)	Wattage	Kelvin	Lumen
2521236	150-1500mm	1-5ft.	13W/m (4W/ft.)	3000K-5000K	1170lm/m (357lm/ft.)
514400001				2700K-6500K	

Mini Tubular R

24V / Emotion

Item Code*	L (mm)	L (ft)	Wattage	Kelvin	Lumen
2522436	150-1500mm	1-5ft.	13W/m (4W/ft.)	3000K-5000K	1170lm/m (357lm/ft.)
514400002				2700K-6500K	

*For daisy chain add -01 to item code (_____-01)
Note: Cord exit right by default unless specified

Additional Accessories

Item Code 12V	Item Code 24V	Accessories	L (mm)	L (ft)
1540601	1540602	Extension Cords for light fixture (Fixture to Driver & Fixture to Fixture)	250mm	1ft.
1540701	1540702		500mm	2ft.
1540801	1540802		1000mm	3ft.
1540901	1540902		2000mm	7ft.
2300012	2300012	Magnetic Mounting Kit (2pcs.)		

Power Supplies

12V / 24V

Product Details	Wattage
MEC Driver w. Distributor Module More informaton about the power supplies on page 118.	12V 18W, 36W, 48W, 60W
	24V 18W, 36W, 48W, 72W, 90W

NOTE: 12V LED lights are only compatible with drivers up to 60W max.

MINI TUBULAR Q



The Mini Tubular Q offers a 120° angle beam and the compact micro chip LED spacing gives a powerful continuous linear light glow.

Product Characteristics

- Available in custom lengths 150mm-2000mm (1-7ft.)
- Available in 3000K, 3500K, 4000K or Emotion (3000-5000K)
- Change color temperature (WW to CW) with Emotion Technology
- CRI >90
- Aluminum heat sink for maximum heat dissipation
- Attached 2m (7ft.) cord 20 AWG, disconnect at 75mm (3"), 12V black, 24V white
- Daisy chain version optional
- Wood mounting kit included
- Magnetic mounting kit optional

Suitable Applications

- Retail Displays
- Casework
- Under Cabinet
- Shelving

Specifications

	120 LED/m	EMOTION 12V	EMOTION 24V
L	150-2000mm (1-7ft.)	150-2000mm (1-7ft.)	150-2000mm (1-7ft.)
Lm	1650lm/m (503lm/ft.)	1000lm/m (305lm/ft.)	1480lm/m (451lm/ft.)
W	15W/m (4.6W/ft.)	10W/m (3W/ft.)	14.8W/m (4.5W/ft.)
Max 18W Driver	1.2m (4ft.)	1.8m (6ft.)	1.2m (4ft.)
Max 36W Driver	2.4m (8ft.)	3.6m (12ft.)	2.4m (8ft.)
Max 48W Driver	3.2m (11ft.)	4.8m (16ft.)	3.2m (11ft.)
Max 60/72W Driver*	4.8m (16ft.)	6m* (20ft.)	4.9m (16ft.)
Max 90W Driver	6m (20ft.)	-	6.1m (20ft.)

* 12V lights are only compatible with drivers up to 60W max.

Photometrics

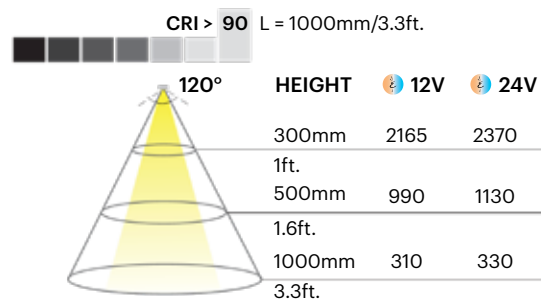

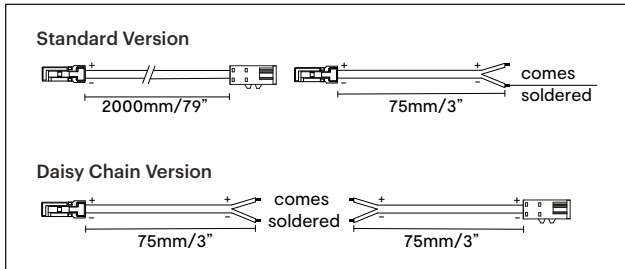
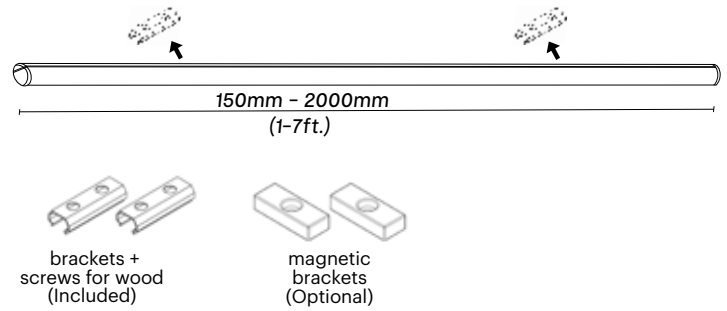
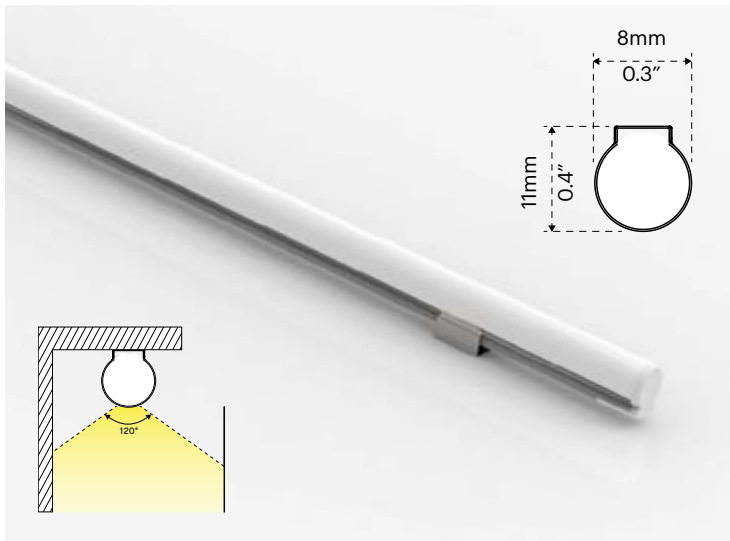

Mini Tubular Q

24V / 120 LED/m

Item Code*	L (mm)	L (ft)	Wattage	Kelvin	Lumen
2422433	150-2000mm	1-7ft.	15W/m (4.6W/ft.)	3000K	1650lm/m (503lm/ft.)
2562435				3500K	
2562443				4000K	

Mini Tubular Q

12V / Emotion

Item Code*	L (mm)	L (ft)	Wattage	Kelvin	Lumen
2421235	150-2000mm	1-7ft.	10W/m (3W/ft.)	3000K-5000K	1000lm/m (305lm/ft.)

Mini Tubular Q

24V / Emotion

Item Code*	L (mm)	L (ft)	Wattage	Kelvin	Lumen
2422435	150-2000mm	1-7ft.	14.8W/m (4.5W/ft.)	3000K-5000K	1480lm/m (451lm/ft.)

*For daisy chain add -01 to item code (_____-01)

NOTE: Cord exit right by default unless specified. Some configurations require a longer production time, please check with your sales representative.

Additional Accessories

Item Code 12V	Item Code 24V	Accessories	L (mm)	L (ft)
1540601	1540602	Extension Cords for light fixture (Fixture to Driver & Fixture to Fixture)	250mm	1ft.
1540701	1540702		500mm	2ft.
1540801	1540802		1000mm	3ft.
1540901	1540902		2000mm	7ft.
2300013	2300013	Magnetic Mounting Kit (2pcs.)		

Power Supplies

12V / 24V

Product Details	Wattage
MEC Driver w. Distributor Module More informaton about the power supplies on page 118.	12V 18W, 36W, 48W, 60W
	24V 18W, 36W, 48W, 72W, 90W

NOTE: 12V LED lights are only compatible with drivers up to 60W max.

MINI TUBULAR IC 2



Standard lengths

Create seamless lighting with the Mini Tubular IC 2. Connect fixtures easily for up to 20ft. of uninterrupted light. Mount on magnetic surfaces or use the included kit for wood surfaces. Features a 140° wide beam angle. Now certified for food handling equipment (NSF/ANSI 2).

Product Characteristics

- Available in 5 lengths ranging from 200mm to 1140mm (8"-46")
- Available in 3000K, 4000K and Emotion (3000K-5000K)
- Change color temperature (WW to CW) with Emotion Technology
- CRI >90
- Aluminum heat sink for maximum heat dissipation
- Fixtures are connectable without any additional accessories
- Wood mounting kit and end caps included
- Integrated magnets for instant mounting
- Certified for: Food Equipment, NSF/ANSI 2:2021

Suitable Applications

- Retail Displays
- Casework
- Under Cabinet
- Shelving

Specifications

	3000K / 4000K & Emotion				
L	200mm (7.9")	300mm (12")	570mm (24")	870mm (34")	1140mm (46")
Lm (3000K / 4000K)	216lm/fixture	324lm/fixture	612lm/fixture	936lm/fixture	1224lm/fixture
Lm (Emotion)	192lm/fixture	288lm/fixture	544lm/fixture	832lm/fixture	1088lm/fixture
W	2.4W/fixture	3.6W/fixture	6.8W/fixture	10.4W/fixture	13.6W/fixture
Max 18W Driver	7 fx.	5 fx.	2 fx.	1 fx.	1 fx.
Max 36W Driver	15 fx.	10 fx.	5 fx.	3 fx.	2 fx.
Max 48W Driver	20 fx.	13 fx.	7 fx.	4 fx.	3 fx.
Max 72W Driver	30 fx.	20 fx.	10 fx.	6 fx.	5 fx.

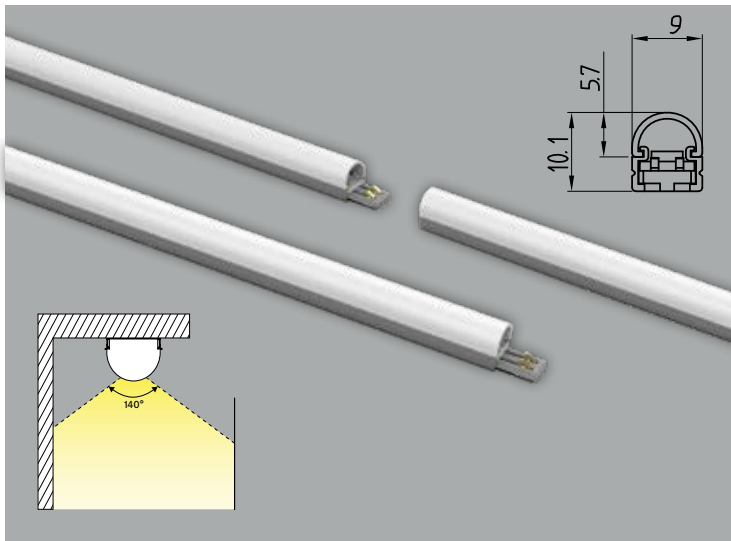

Mini Tubular IC 2

24V

Item Code	L (mm)	L (in)	Wattage	Kelvin	Lumen
1352430-8	200mm	8"	2.4W/fx.	3000K	216lm/fx.
1352430-12	300mm	12"	3.6W/fx.		324lm/fx.
1352430-24	570mm	24"	6.8W/fx.		612lm/fx.
1352430-34	870mm	34"	10.4W/fx.		936lm/fx.
1352430-46	1140mm	46"	13.6W/fx.		1224lm/fx.

Mini Tubular IC 2

24V

Item Code	L (mm)	L (in)	Wattage	Kelvin	Lumen
1352440-8	200mm	8"	2.4W/fx.	4000K	216lm/fx.
1352440-12	300mm	12"	3.6W/fx.		324lm/fx.
1352440-24	570mm	24"	6.8W/fx.		612lm/fx.
1352440-34	870mm	34"	10.4W/fx.		936lm/fx.
1352440-46	1140mm	46"	13.6W/fx.		1224lm/fx.

Mini Tubular IC 2

24V / Emotion

Item Code	L (mm)	L (in)	Wattage	Kelvin	Lumen
1352435-8	200mm	8"	2.4W/fx.	3000K-5000K	216lm/fx.
1352435-12	300mm	12"	3.6W/fx.		324lm/fx.
1352435-24	570mm	24"	6.8W/fx.		612lm/fx.
1352435-34	870mm	34"	10.4W/fx.		936lm/fx.
1352435-46	1140mm	46"	13.6W/fx.		1224lm/fx.

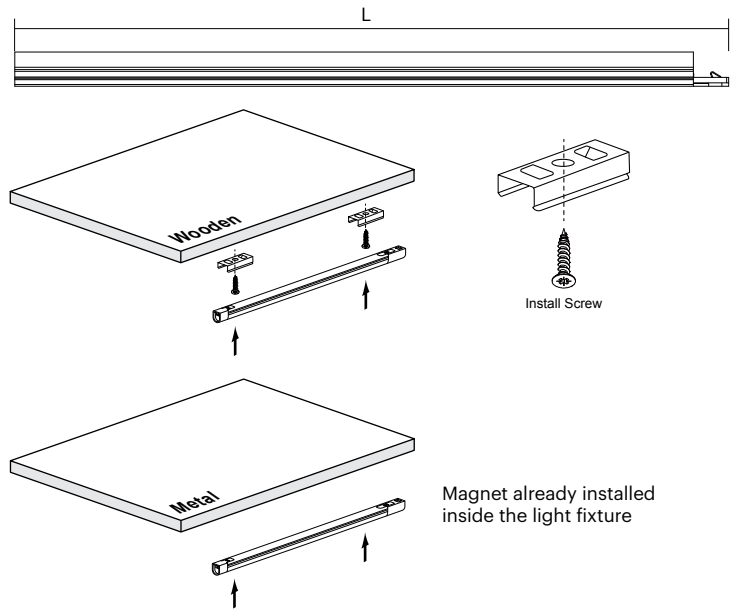

A



B



Connection Cords

Item Code	Accessories	L (mm)	L (in)
1352401	A - Input Connector (22 AWG)	100mm	3.9"
1352402		2000mm	78.7"
1352403	B - Connection Cord (22 AWG)	25mm	1"
1352404		300mm	11.8"
1352405		1000mm	39"

Additional Accessories

Item Code	Accessories	L (mm)	L (ft)
1540602	Extension Cords for light fixture (Fixture to Driver & Fixture to Fixture)	250mm	1ft.
1540702		500mm	2ft.
1540802		1000mm	3ft.
1540902		2000mm	7ft.

Power Supplies

24V

Product Details	Wattage
MEC Driver w. Distributor Module	24V 18W, 36W, 48W, 72W, 90W
More information about the power supplies on page 118.	

CALI



Custom: 150-2500mm

Cali is a surface mounted linear fixture with an extremely low profile. The diffuser offers a dot-free light effect while maintaining a high light output.

Product Characteristics

- Available in custom lengths 150-2500mm (1-8ft.)
- Standard in 3000K, 4000K, and Emotion. On request in 2700K, 3500K, 5000K, 6000K with extended lead time.
- Change color temperature (WW to CW) with Emotion Technology
- CRI >90
- Daisy chain version optional
- Wood mounting kit included
- Low profile magnetic mounting clips optional
- Attached 2m (7ft.) cord 22 AWG, disconnect at 75mm (3"), 12V black, 24V white

Suitable Applications

- Retail Displays
- Casework
- Under Cabinet
- Shelving

Specifications

	112 LED/m	160 LED/m	EMOTION
L	150-2500mm (1-8ft.)	150-2500mm (1-8ft.)	150-2500mm (1-8ft.)
Lm	1200lm/m (365lm/ft.)	1950lm/m (594lm/ft.)	1170lm/m (357lm/ft.)
W	8W/m (2.4W/ft.)	13W/m (4W/ft.)	13W/m (4W/ft.)
Max 18W Driver	2.2m (7ft.)	1.4m (5ft.)	1.4m (5ft.)
Max 36W Driver	4.5m (15ft.)	2.8m (9ft.)	2.8m (9ft.)
Max 48W Driver	6m (20ft.)	3.7m (12ft.)	3.7m (12ft.)
Max 72W Driver	9m (29ft.)	5.5m (18ft.)	5.5m (18ft.)
Max 90W Driver	11.2m (37ft.)	6.9m (23ft.)	6.9m (23ft.)

Photometrics

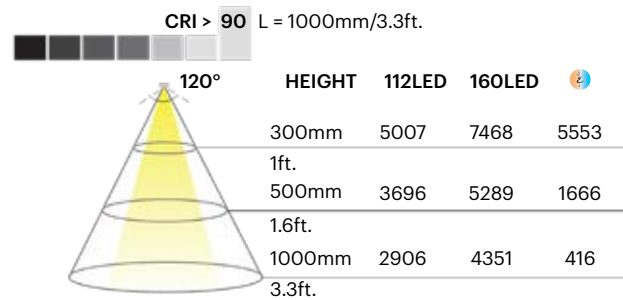

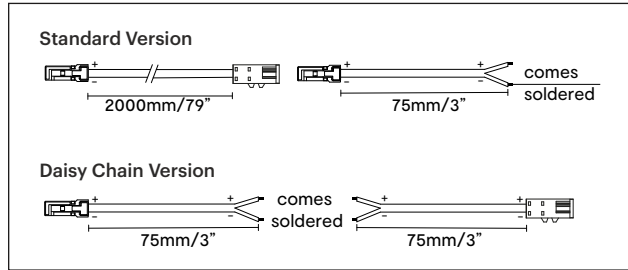
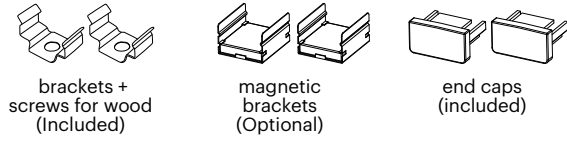
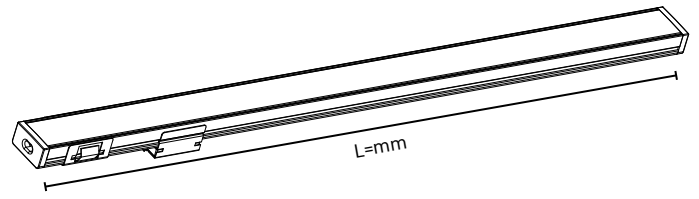
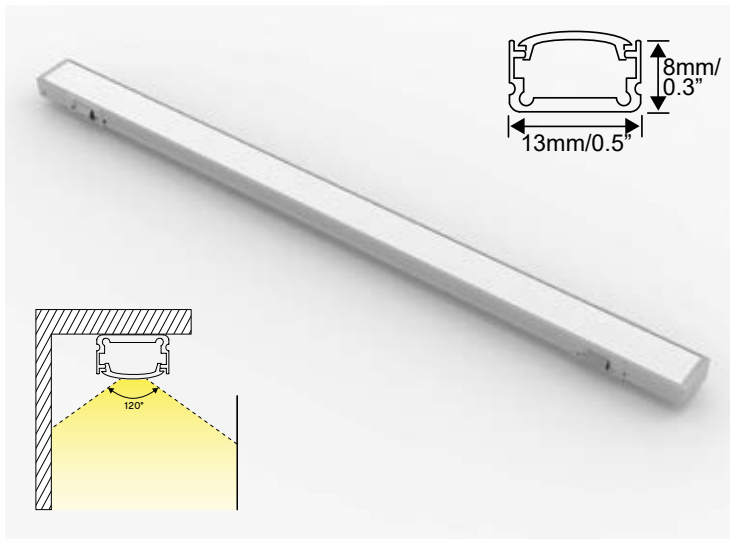

Cali

24V / 112 LED/m

Item Code / Aluminum	Item Code / Black	L (mm)	L (ft)	Wattage	Kelvin	Lumen
2752428'	2752427'	150-2500mm	1-8ft.	8W/m (2.4W/ft.)	2700K	1200lm/m (365lm/ft.)
2752431	2752430				3000K	
2752436'	2752435'				3500K	
2752441	2752440				4000K	
2752451'	2752450'				5000K	
2752461'	2752460'				6000K	

¹Available with expected lead time of 4 weeks + shipping.

Additional Accessories

Item Code	Accessories	L (mm/ft)
1540602	Extension Cords for light fixture (Fixture to Driver & Fixture to Fixture)	250mm / 1ft.
1540702		500mm / 2ft.
1540802		1000mm / 3ft.
1540902		2000mm / 7ft.
3111004		Magnetic Mounting Kit Black (2pcs.)
3111006	Magnetic Mounting Kit Aluminum (2pcs.)	

Cali

24V / 160 LED/m

Item Code / Aluminum	Item Code / Black	L (mm)	L (ft)	Wattage	Kelvin	Lumen
2008227'	2007227'	150-2500mm	1-8ft.	13W/m (4W/ft.)	2700K	1950lm/m (594lm/ft.)
2008230	2007230				3000K	
2008235'	2007235'				3500K	
2008240	2007240				4000K	
2008250'	2007250'				5000K	
2008260'	2007260'				6000K	

¹Available with expected lead time of 4 weeks + shipping.

Power Supplies

24V

Product Details	Wattage
MEC Driver w. Distributor Module	24V 18W, 36W, 48W, 72W, 90W
More information about the power supplies on page 118.	

Cali

24V / Emotion

Item Code / Aluminum	Item Code / Black	L (mm)	L (ft)	Wattage	Kelvin	Lumen
2802436	2802435	150-2500mm	1-8ft.	13W/m (4W/ft.)	3000K-5000K	1170m/m (357lm/ft.)
2002436	2842436				2700K-6500K	

* For daisy chain add -01 to item code (_____-01)
Note: Cord exit right by default unless specified

MINI



Custom: 150-3000mm

The Mini is a discreet and versatile linear light. It offers easy installation with magnets already attached. With a 35° angled light output it's a perfect solution for under-shelf lighting.

Product Characteristics

- Available in custom lengths 150mm-3000mm (1-10ft.)
- Optic designed to ensure uniform light diffusion
- Installation with magnets, kit included
- Available in 3000K, 3500K, 4000K, and Emotion (additional color temperatures available on request)
- Change color temperature (WW to CW) with Emotion Technology
- Attached 2m (7ft.) cord 22 AWG, disconnect at 75mm (3"), 24V white
- Wood mounting kit optional

Suitable Applications

- Retail Displays
- Casework
- Shelving

Specifications

	120 LED/m		EMOTION
L	150-3000mm (1-10ft.)	150-3000mm (1-10ft.)	150-3000mm (1-10ft.)
Lm	858lm/m (262lm/ft.)	1650lm/m (503lm/ft.)	1628lm/m (496lm/ft.)
W	7.8W/m (2.4W/ft.)	15W/m (4.6W/ft.)	14.8W/m (4.5W/ft.)
Max 18W Driver	2.3m (8ft.)	1.2m (4ft.)	1.2m (4ft.)
Max 36W Driver	4.6m (15ft.)	2.4m (8ft.)	2.4m (8ft.)
Max 48W Driver	6.2m (20ft.)	3.2m (11ft.)	3.2m (11ft.)
Max 72W Driver	9.2m (30ft.)	4.8m (16ft.)	4.9m (16ft.)
Max 90W Driver	11.5m (38ft.)	6m (20ft.)	6.1m (20ft.)

Photometrics

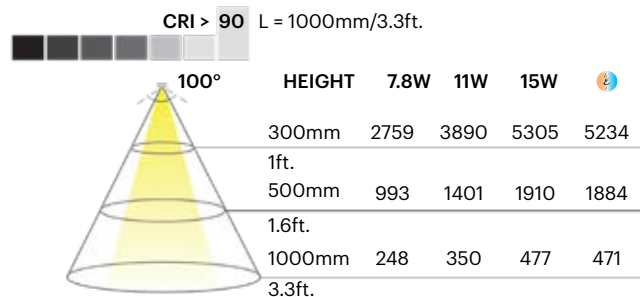

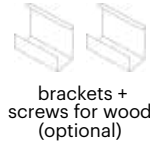
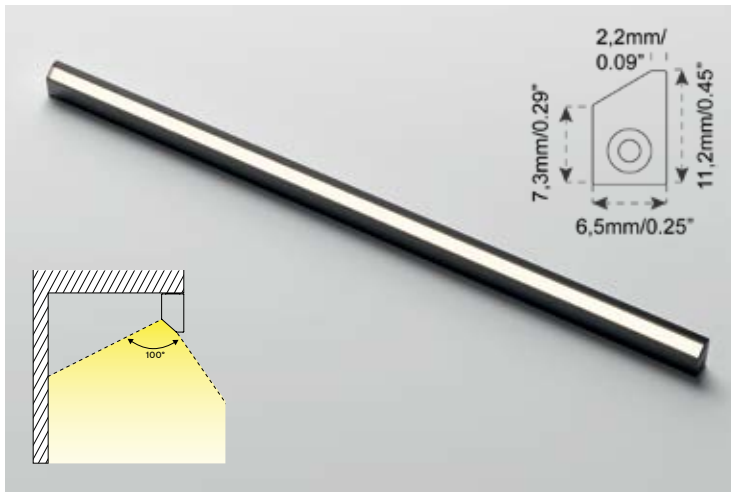

Cord Specifications

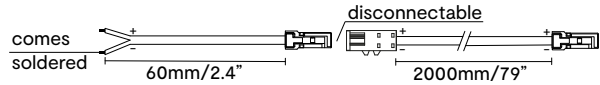

Mini

24V / 120 LED/m

Item Code / Aluminum	Item Code / Black	L (mm)	L (ft)	Wattage	Kelvin	Lumen
on request	on request	150-3000mm	1-10ft.	7.8W/m (2.4W/ft.)	3000K	858lm/m (262lm/ft.)
2682440	513900002				4000K	

Additional color temperatures (CCT) are available on request. Expected lead time 4 weeks + shipping.

Mini

24V / 120 LED/m

Item Code / Aluminum	Item Code / Black	L (mm)	L (ft)	Wattage	Kelvin	Lumen
2832430	2822430	150-3000mm	1-10ft.	15W/m (4.6W/ft.)	3000K	1650lm/m (503lm/ft.)
2832435	2822435				3500K	
2832440	2822440				4000K	

Additional color temperatures (CCT) are available on request. Expected lead time 4 weeks + shipping.

Mini

24V / Emotion

Item Code / Aluminum	Item Code / Black	L (mm)	L (ft)	Wattage	Kelvin	Lumen
2892435	2732435	150-3000mm	1-10ft.	14.8W/m (4.5W/ft.)	3000K-5000K	1628lm/m (496lm/ft.)

NOTE: Cable exit left by default. Some configurations require a longer production time, please check with your sales representative.

Additional Accessories

Item Code	Accessories	L (mm/ft)
1540602	Extension Cords for light fixture (Fixture to Driver & Fixture to Fixture)	250mm / 1ft.
1540702		500mm / 2ft.
1540802		1000mm / 3ft.
1540902		2000mm / 7ft.
1170003	Wood Mounting Kit, black (2pcs.)	
1170004	Wood Mounting Kit, aluminum (2pcs.)	

Power Supplies

24V

Product Details	Wattage
<p>MEC Driver w. Distributor Module</p> <p>More informaton about power supplies on page 118.</p>	<p>24V 18W, 36W, 48W, 72W, 90W</p>

MICROLINE



The Microline is the smallest linear light in our collection, featuring a COB LED strip for a smooth, diode-free light output—no lens required. Its angled, asymmetrical shape reduces glare and provides full illumination, making it ideal for showcases and corner applications

Product Characteristics

- Available in custom lengths 150mm-2000mm (0.5-6.5ft.)
- Available in 3000K and 4000K
- CRI >90
- Aluminum heat sink for maximum heat dissipation
- Attached 2m (7ft.) cord 22 AWG, disconnect at 75mm (3"), 24V white
- Daisy chain version optional
- Adhesive tape for mounting included
- Extremely small aluminum profile

Suitable Applications

- Retail Displays
- Casework
- Cabinet Interiors
- Shelving
- Under Cabinet

Specifications

	480 Chip/m COB
L	150-2000mm (0.5-6.5ft.)
Lm	340lm/m (103lm/ft.)
W	6W/m (1.8W/ft.)
Max 18W Driver	3m (9.8ft.)
Max 36W Driver	6m (19.6ft.)
Max 48W Driver	8m (26.2ft.)
Max 72W Driver	12m (39.3ft.)
Max 90W Driver	15m (49.2ft.)

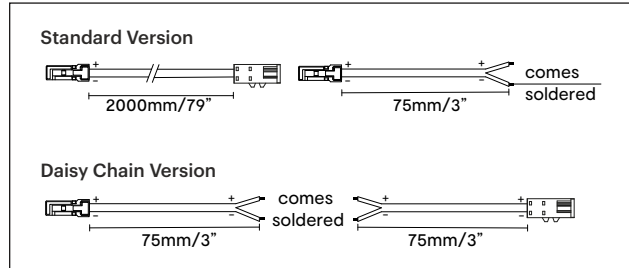
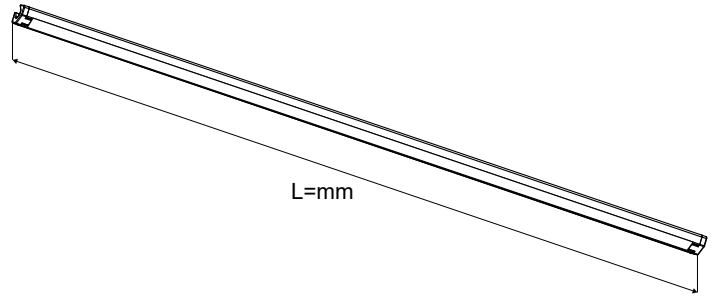
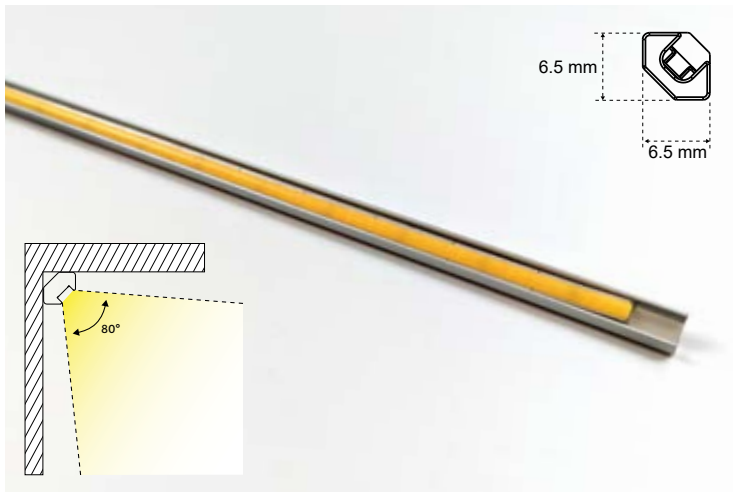

Microline

480 Chip/m COB / 24V

Item Code*	L (mm)**	L (ft)	Wattage	Kelvin	Lumen
513400001	150-2000mm	0.5-6.5ft.	6W/m (1.8W/ft.)	3000K	340lm/m (103lm/ft.)
2840024				4000K	360lm/m (110lm/ft.)

* For daisy chain add -01 to item code (_____-01)
 ** Longer sizes available on special request.

Additional Accessories

Item Code	Accessories	L (mm/ft)
1540602	Extension Cords for light fixture (Fixture to Driver & Fixture to Fixture)	250mm / 1ft.
1540702		500mm / 2ft.
1540802		1000mm / 3ft.
1540902		2000mm / 7ft.

Power Supplies

24V

Product Details	Wattage
MEC Driver w. Distributor Module More informaton about power supplies on page 118.	24V 18W, 36W, 48W, 72W, 90W 

NEW SIRENUSE



Custom: 200-3000mm



Sirenuse is a sleek linear lighting fixture crafted from aluminum and polycarbonate, perfect for easy mounting onto wood surfaces via clip-in extension. Its innovative design allows for a 180-degree light distribution both forward and up/down simultaneously, providing optimal visual comfort. Sirenuse is perfect for lighting wooden shelves.

Product Characteristics

- Available in custom lengths 200mm-3000mm (1-10ft.)
- Available in 3000K, 4000K, and Emotion (additional color temperatures available on request)
- Change color temperature (WW to CW) with Emotion Technology
- CRI >90
- 180-degree light distribution
- Aluminum heat sink for maximum heat dissipation
- Attached 2m (7ft.) cord 22 AWG, disconnect at 75mm (3"), 12V black, 24V white
- Easy mounting via clip-in extension

Suitable Applications

- Retail Displays
- Casework
- Closets
- Shelving

Specifications

	112 LED/m	160 LED/m	EMOTION
L	200-3000mm (1-10ft.)	200-3000mm (1-10ft.)	200-3000mm (1-10ft.)
Lm	1200lm/m (365lm/ft.)	1950lm/m (594lm/ft.)	1170lm/m (357lm/ft.)
W	8W/m (2.4W/ft.)	13W/m (4W/ft.)	13W/m (4W/ft.)
Max 18W Driver	2.2m (7ft.)	1.4m (5ft.)	1.4m (5ft.)
Max 36W Driver	4.5m (15ft.)	2.8m (9ft.)	2.8m (9ft.)
Max 48W Driver	6m (20ft.)	3.7m (12ft.)	3.7m (12ft.)
Max 60/72W Driver	9m (29ft.)	5.5m (18ft.)	5.5m (18ft.)
Max 90W Driver	11.2m (37ft.)	6.9m (23ft.)	6.9m (23ft.)

* 12V lights are only compatible with drivers up to 60W max.

Photometrics

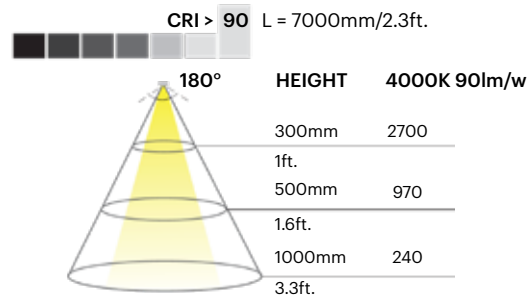

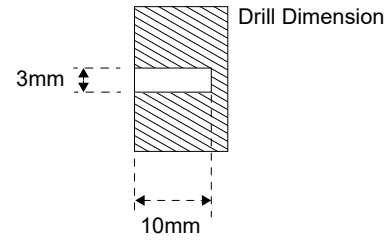
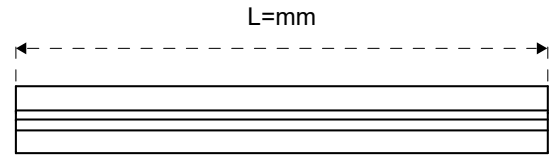
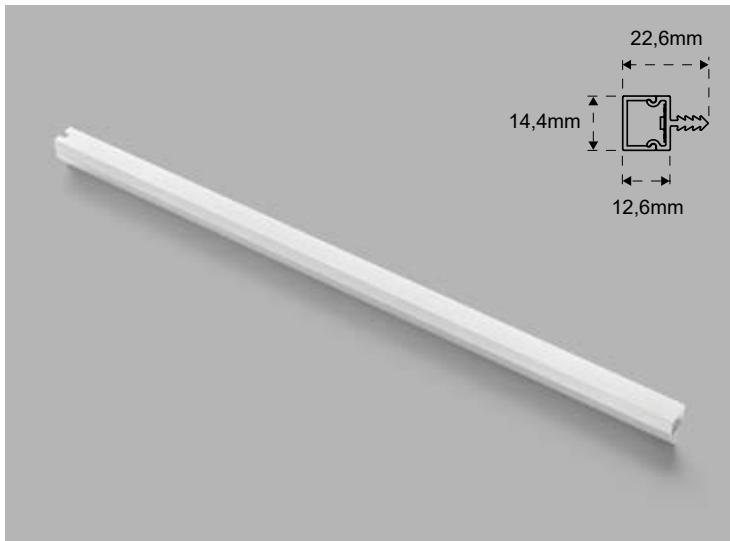

Sirenuse

24V / 112 LED/m

Item Code	L (mm)	L (ft)	Wattage	Kelvin	Lumen
590500275	200-3000mm	1-10ft.	8W/m (2.4W/ft.)	3000K	1200lm/m (365lm/ft.)
590500276				4000K	

Sirenuse

24V / 160 LED/m

Item Code	L (mm)	L (ft)	Wattage	Kelvin	Lumen
590500277	200-3000mm	1-10ft.	13W/m (4W/ft.)	3000K	1950lm/m (594lm/ft.)
590500278				4000K	

Sirenuse

12V / Emotion

Item Code	L (mm)	L (ft)	Wattage	Kelvin	Lumen
590500279	200-3000mm	1-10ft.	13W/m (4W/ft.)	3000K-5000K	1170lm/m (357lm/ft.)
590500280				2700K-6500K	

Sirenuse

24V / Emotion

Item Code	L (mm)	L (ft)	Wattage	Kelvin	Lumen
590500281	200-3000mm	1-10ft.	13W/m (4W/ft.)	3000K-5000K	1170lm/m (357lm/ft.)
590500282				2700K-6500K	

Additional Accessories

Item Code 12V	Item Code 24V	Accessories	L (mm)	L (ft)
1540601	1540602	Extension Cords for light fixture (Fixture to Driver & Fixture to Fixture)	250mm	1ft.
1540701	1540702		500mm	2ft.
1540801	1540802		1000mm	3ft.
1540901	1540902		2000mm	7ft.

Power Supplies

12V / 24V

Product Details	Wattage
MEC Driver w. Distributor Module	12V 18W, 36W, 48W, 60W
	24V 18W, 36W, 48W, 72W, 90W

NOTE: 12V LED lights are only compatible with drivers up to 60W max.

NEW VIVARA



Vivara is a uniquely crafted linear profile specifically tailored for glass shelf installations, offering a captivating effect and precise light distribution.

Product Characteristics

- Available in custom lengths 150mm-3000mm (0.5-10ft.)
- Available in 3000K, 4000K, and Emotion (additional color temperatures available on request)
- Change color temperature (WW to CW) with Emotion Technology
- CRI >90
- Aluminum heat sink for maximum heat dissipation
- Attached 2m (7ft.) cord 22 AWG, disconnect at 75mm (3"), 12V black, 24V white
- Daisy chain version optional
- Suitable for glass with 8mm (0.3") thickness
- Easy installation via snap-on profile

Suitable Applications

- Retail Displays
- Glass or Plexiglass Installations
- Glass Shelving

Specifications

	112 LED/m	160 LED/m	EMOTION
L	150-3000mm (0.5-10ft.)	150-3000mm (0.5-10ft.)	150-3000mm (0.5-10ft.)
Lm	1200lm/m (365lm/ft.)	1950lm/m (594lm/ft.)	1170lm/m (357lm/ft.)
W	8W/m (2.4W/ft.)	13W/m (4W/ft.)	13W/m (4W/ft.)
Max 18W Driver	2.2m (7ft.)	1.4m (5ft.)	1.4m (5ft.)
Max 36W Driver	4.5m (15ft.)	2.8m (9ft.)	2.8m (9ft.)
Max 48W Driver	6m (20ft.)	3.7m (12ft.)	3.7m (12ft.)
Max 60/72W Driver	9m (29ft.)	5.5m (18ft.)	5.5m (18ft.)
Max 90W Driver	11.2m (37ft.)	6.9m (23ft.)	6.9m (23ft.)

* 12V lights are only compatible with drivers up to 60W max.

Photometrics

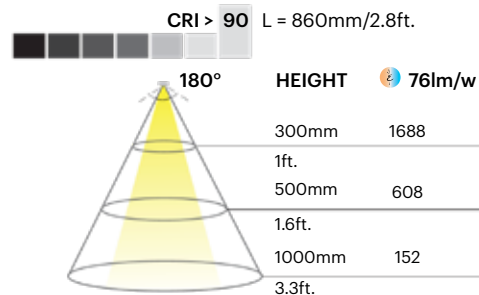

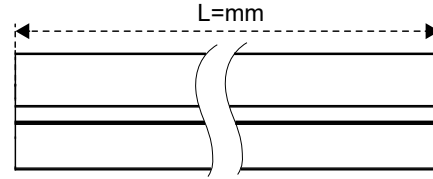
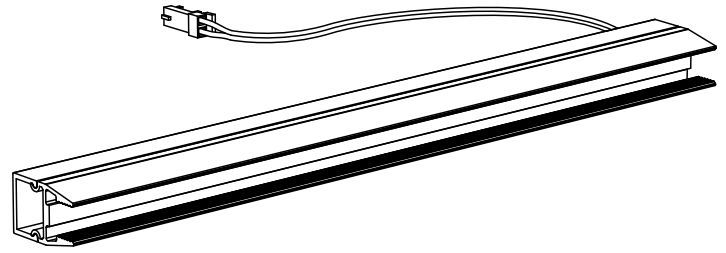

Vivara

24V / 112 LED/m

Item Code	L (mm)	L (ft)	Wattage	Kelvin	Lumen
518000153	150-3000mm	0.5-10ft.	8W/m (2.4W/ft.)	3000K	1200lm/m (365lm/ft.)
518000154				4000K	

Vivara

24V / 160 LED/m

Item Code	L (mm)	L (ft)	Wattage	Kelvin	Lumen
518000155	150-3000mm	0.5-10ft.	13W/m (4W/ft.)	3000K	1950lm/m (594lm/ft.)
518000156				4000K	

Vivara

12V / Emotion

Item Code	L (mm)	L (ft)	Wattage	Kelvin	Lumen
518000157	150-3000mm	0.5-10ft.	13W/m (4W/ft.)	3000K-5000K	1170lm/m (357lm/ft.)
518000158				2700K-6500K	

Vivara

24V / Emotion

Item Code	L (mm)	L (ft)	Wattage	Kelvin	Lumen
518000159	150-3000mm	0.5-10ft.	13W/m (4W/ft.)	3000K-5000K	1170lm/m (357lm/ft.)
518000160				2700K-6500K	

Additional Accessories

Item Code 12V	Item Code 24V	Accessories	L (mm)	L (ft)
1540601	1540602	Extension Cords for light fixture (Fixture to Driver & Fixture to Fixture)	250mm	1ft.
1540701	1540702		500mm	2ft.
1540801	1540802		1000mm	3ft.
1540901	1540902		2000mm	7ft.

Power Supplies

12V / 24V

Product Details	Wattage
MEC Driver w. Distributor Module	12V 18W, 36W, 48W, 60W
	24V 18W, 36W, 48W, 72W, 90W

NOTE: 12V LED lights are only compatible with drivers up to 60W max.

SKYLINE



The Skyline is a high efficiency LED fixture with a low profile. The angled beam directs light towards the product. Ideal applications for the Skyline include glass, wood or metal shelving.

Product Characteristics

- Available in custom lengths 150mm-2500mm (1-8ft.)
- Available in 3000K, 4000K, 5000K and Emotion (additional color temperatures available on request)
- Change color temperature (WW to CW) with Emotion Technology
- CRI >90
- Aluminum heat sink for maximum heat dissipation
- Attached 2m (7ft.) cord 22 AWG, disconnect at 75mm (3"), 12V black, 24V white
- Daisy chain version optional
- Wood mounting kit included
- Glass mounting optional

Suitable Applications

- Retail Displays
- Casework
- Cabinet Interiors
- Shelving
- Under Cabinet

Specifications

	112 LED/m	160 LED/m	EMOTION
L	150-2500mm (1-8ft.)	150-2500mm (1-8ft.)	150-2500mm (1-8ft.)
Lm	1200lm/m (365lm/ft.)	1950lm/m (594lm/ft.)	1170lm/m (357lm/ft.)
W	8W/m (2.4W/ft.)	13W/m (4W/ft.)	13W/m (4W/ft.)
Max 18W Driver	2.2m (7ft.)	1.4m (5ft.)	1.4m (5ft.)
Max 36W Driver	4.5m (15ft.)	2.8m (9ft.)	2.8m (9ft.)
Max 48W Driver	6m (20ft.)	3.7m (12ft.)	3.7m (12ft.)
Max 60/72W Driver*	9m (29ft.)	5.5m (18ft.)	5.5m (18ft.)
Max 90W Driver	11.2m (37ft.)	6.9m (23ft.)	6.9m (23ft.)

* 12V lights are only compatible with drivers up to 60W max.

Photometrics

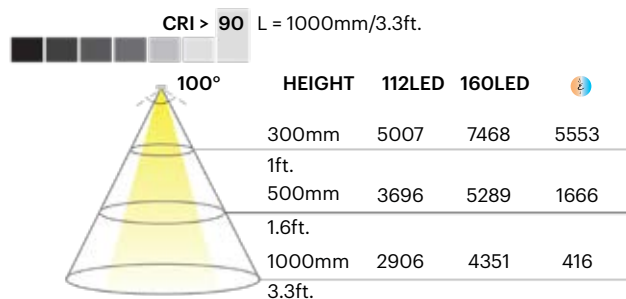

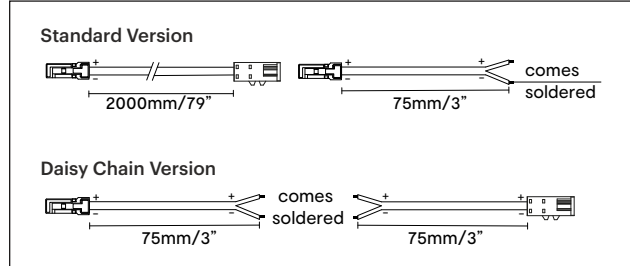
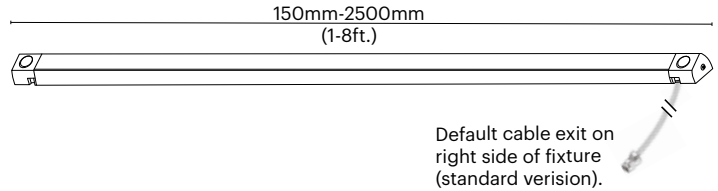
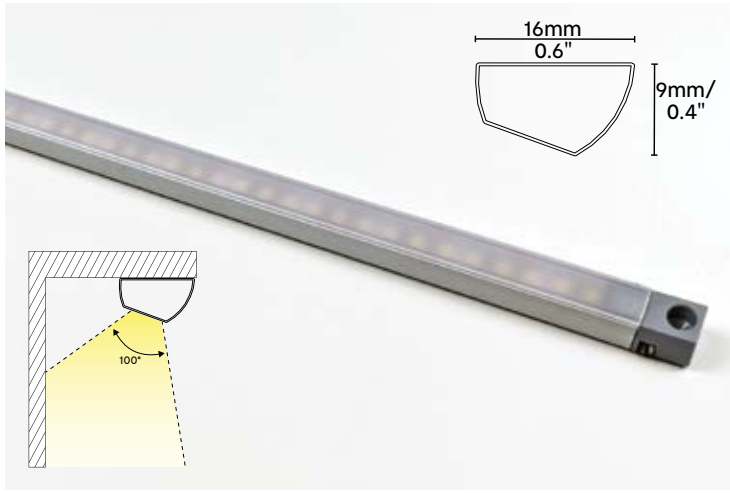

24V / 112 LED/m

Item Code	L (mm)	L (ft)	Wattage	Kelvin	Lumen
2122430	150-2500mm	1-8ft.	8W/m (2.4W/ft.)	3000K	1200lm/m (365lm/ft.)
On request				3500K	
2122440				4000K	
521700001				5000K	

Additional color temperatures (CCT) are available on request. Expected lead time 4 weeks + shipping.

Additional Accessories

Item Code / 24V*	Accessories	L (mm/ft)
1540602	Extension Cords for light fixture (Fixture to Driver & Fixture to Fixture)	250mm / 1ft.
1540702		500mm / 2ft.
1540802		1000mm / 3ft.
1540902		2000mm / 7ft.

*12V Extension Cords see page 133.

24V / 160 LED/m

Item Code	L (mm)	L (ft)	Wattage	Kelvin	Lumen
2132430	150-2500mm	1-8ft.	13W/m (4W/ft.)	3000K	1950lm/m (594lm/ft.)
On request				3500K	
2132440				4000K	
2186150				5000K	

Additional color temperatures (CCT) are available on request. Expected lead time 4 weeks + shipping.

Power Supplies

12V / 24V

Product Details	Wattage
MEC Driver w. Distributor Module	12V 18W, 36W, 48W, 60W
More information about power supplies on page 118.	24V 18W, 36W, 48W, 72W, 90W

NOTE: 12V LED lights are only compatible with drivers up to 60W max.

Skyline

Emotion

Item Code / 12V*	Item Code / 24V*	L (mm)	L (ft)	Wattage	Kelvin	Lumen
2312346	521700003	150-2500mm	1-8ft.	13W/m (4W/ft.)	3000K- 5000K	1170lm/m (357lm/ft.)
521700005	2324346				2700K- 6500K	

* For daisy chain add -01 to item code (_____-01)
Note: Cord exit right by default unless specified

12V available on request.

MEC CORNER



The MEC Corner is ideal for displays or under cabinet lighting. The 45° angle design is perfect for corner installations. The wide lens is designed to produce a 90° beam angle to fully illuminate the space from the corner.

Product Characteristics

- Available in custom lengths 150mm-2500mm (1-8ft.)
- Available in 3000K, 4000K, and Emotion (additional color temperatures available on request)
- Change color temperature (WW to CW) with Emotion Technology
- CRI >90
- Aluminum heat sink for maximum heat dissipation
- Attached 2m (7ft.) cord 22 AWG, disconnect at 75mm (3"), 12V black, 24V white
- Daisy chain version optional
- Wood mounting kit included

Suitable Applications

- Retail Displays
- Cabinet Interiors
- Under Cabinet
- Casework
- Shelving

Specifications

	112 LED/m	160 LED/m	EMOTION
L	150-2500mm (1-8ft.)	150-2500mm (1-8ft.)	150-2500mm (1-8ft.)
Lm	1200lm/m (365lm/ft.)	1950lm/m (594lm/ft.)	1170lm/m (357lm/ft.)
W	8W/m (2.4W/ft.)	13W/m (4W/ft.)	13W/m (4W/ft.)
Max 18W Driver	2.2m (7ft.)	1.4m (5ft.)	1.4m (5ft.)
Max 36W Driver	4.5m (15ft.)	2.8m (9ft.)	2.8m (9ft.)
Max 48W Driver	6m (20ft.)	3.7m (12ft.)	3.7m (12ft.)
Max 60/72W Driver*	9m (29ft.)	5.5m (18ft.)	5.5m (18ft.)
Max 90W Driver	11.2m (37ft.)	6.9m (23ft.)	6.9m (23ft.)

* 12V lights are only compatible with drivers up to 60W max.

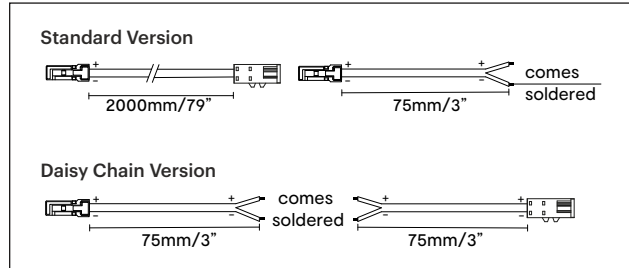
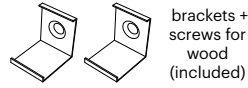
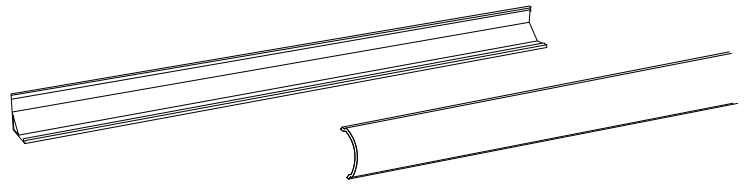
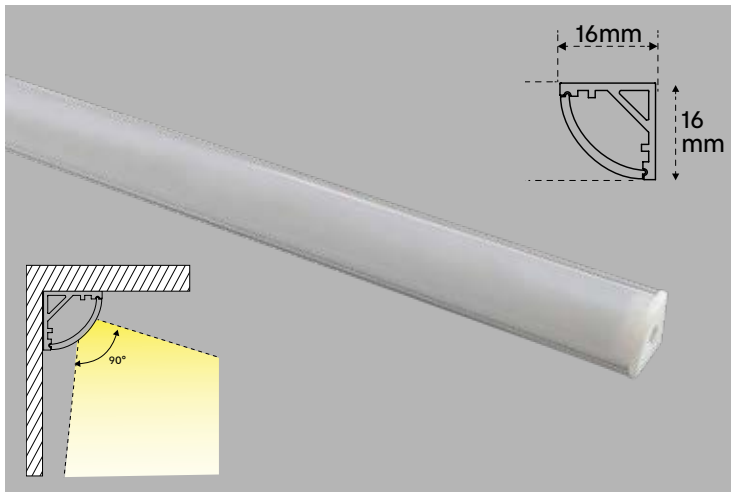

24V / 112 LED/m					
Item Code	L (mm)	L (ft)	Wattage	Kelvin	Lumen
513000001	150-2500mm	1-8ft.	8W/m (2.4W/ft.)	3000K	1200lm/m (365lm/ft.)
513000002				4000K	

Additional color temperatures (CCT) are available on request. Expected lead time 4 weeks + shipping.

24V / 160 LED/m					
Item Code	L (mm)	L (ft)	Wattage	Kelvin	Lumen
2592430	150-2500mm	1-8ft.	13W/m (4W/ft.)	3000K	1950lm/m (594lm/ft.)
513000003				4000K	

Additional color temperatures (CCT) are available on request. Expected lead time 4 weeks + shipping.

MEC Corner							Emotion	
Item Code / 12V*	Item Code / 24V*	L (mm)	L (ft)	Wattage	Kelvin	Lumen		
2591235	513000005	150-2500mm	1-8ft.	13W/m (4W/ft.)	3000K- 5000K	1170lm/m (357lm/ft.)		
513000004	513000006				2700K- 6500K			

* For daisy chain add -01 to item code (_____-01)
 Note: Cord exit right by default unless specified
 12V available on request.

Additional Accessories

Item Code / 24V*	Accessories	L (mm/ft)
1540602	Extension Cords for light fixture (Fixture to Driver & Fixture to Fixture)	250mm / 1ft.
1540702		500mm / 2ft.
1540802		1000mm / 3ft.
1540902		2000mm / 7ft.

*12V Extension Cords see page 133.

Power Supplies

12V / 24V

Product Details	Wattage
MEC Driver w. Distributor Module	12V 18W, 36W, 48W, 60W
More information about power supplies on page 118.	24V 18W, 36W, 48W, 72W, 90W

NOTE: 12V LED lights are only compatible with drivers up to 60W max.

MEC QUATTRO



Custom: 150-2500mm

The MEC Quattro has a square profile and works well under cabinet lighting. The 45° angle profile design is perfect for corner installations. The square lens is designed to produce a wide beam angle to fully illuminate the space from a corner.

Product Characteristics

- Available in custom lengths 150mm-2500mm (1-8ft.)
- Available in 3000K, 4000K, and Emotion (additional color temperatures available on request)
- Change color temperature (WW to CW) with Emotion Technology
- CRI >90
- Aluminum heat sink for maximum heat dissipation
- Attached 2m (7ft.) cord 22 AWG, disconnect at 75mm (3"), 12V black, 24V white
- Daisy chain version optional
- Wood mounting kit included

Suitable Applications

- Corner Applications
- Cabinet Interiors
- Under Cabinet
- Casework
- Shelving

Specifications

	112 LED/m	160 LED/m	EMOTION
L	150-2500mm (1-8ft.)	150-2500mm (1-8ft.)	150-2500mm (1-8ft.)
Lm	1200lm/m (365lm/ft.)	1950lm/m (594lm/ft.)	1170lm/m (357lm/ft.)
W	8W/m (2.4W/ft.)	13W/m (4W/ft.)	13W/m (4W/ft.)
Max 18W Driver	2.2m (7ft.)	1.4m (5ft.)	1.4m (5ft.)
Max 36W Driver	4.5m (15ft.)	2.8m (9ft.)	2.8m (9ft.)
Max 48W Driver	6m (20ft.)	3.7m (12ft.)	3.7m (12ft.)
Max 60/72W Driver*	9m (29ft.)	5.5m (18ft.)	5.5m (18ft.)
Max 90W Driver	11.2m (37ft.)	6.9m (23ft.)	6.9m (23ft.)

* 12V lights are only compatible with drivers up to 60W max.

Photometrics

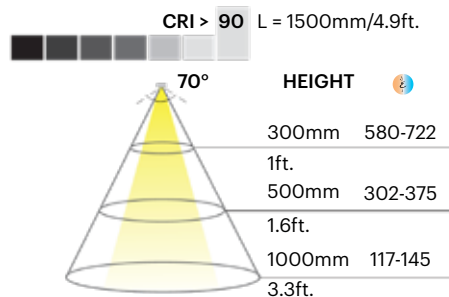

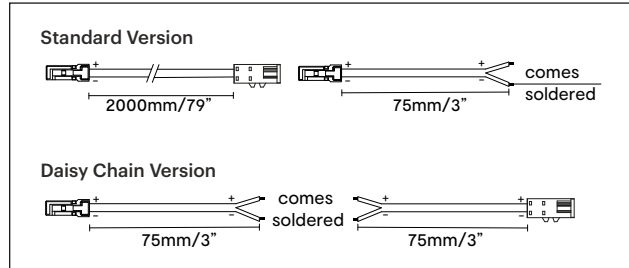
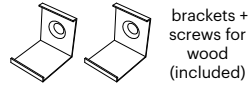
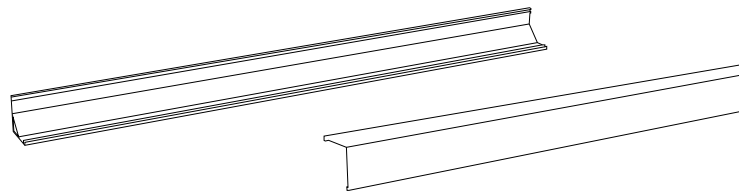
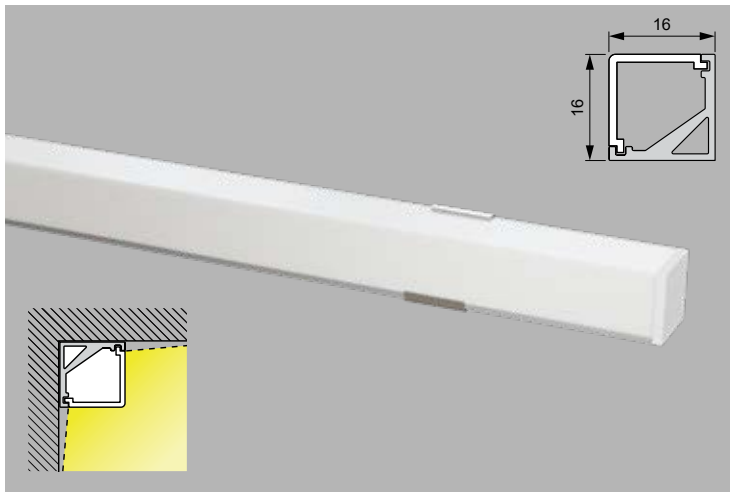

24V / 112 LED/m

Item Code	L (mm)	L (ft)	Wattage	Kelvin	Lumen
515300003	150-2500mm	1-8ft.	8W/m (2.4W/ft.)	3000K	1200lm/m (365lm/ft.)
515300004				4000K	

Additional color temperatures (CCT) are available on request. Expected lead time 4 weeks + shipping.

24V / 160 LED/m

Item Code	L (mm)	L (ft)	Wattage	Kelvin	Lumen
515300007	150-2500mm	1-8ft.	13W/m (4W/ft.)	3000K	1950lm/m (594lm/ft.)
1331640				4000K	

Additional color temperatures (CCT) are available on request. Expected lead time 4 weeks + shipping.

MEC Quattro

Item Code / 12V*	Item Code / 24V*	L (mm)	L (ft)	Wattage	Kelvin	Lumen
515300008	515300010	150-2500mm	1-8ft.	13W/m (4W/ft.)	3000K- 5000K	1170lm/m (357lm/ft.)
515300009	515300011				2700K- 6500K	

* For daisy chain add -01 to item code (_____-01)

Note: Cord exit right by default unless specified

12V available on request.

Additional Accessories

Item Code / 24V*	Accessories	L (mm/ft)
1540602	Extension Cords for light fixture (Fixture to Driver & Fixture to Fixture)	250mm / 1ft.
1540702		500mm / 2ft.
1540802		1000mm / 3ft.
1540902		2000mm / 7ft.

*12V Extension Cords see page 133.

Power Supplies

12V / 24V

Product Details	Wattage
MEC Driver w. Distributor Module	12V 18W, 36W, 48W, 60W
More information about power supplies on page 118.	24V 18W, 36W, 48W, 72W, 90W

NOTE: 12V LED lights are only compatible with drivers up to 60W max.

MINI NOOR



Custom: 150-3000mm

The Mini Noor is a discreet and versatile linear light for recessed applications. It offers easy installation with fixing springs already attached. With a 35° angled light output it is a ideal solution for under-shelf lighting or to illuminate cabinet or closet interiors by installing the fixture along the side panels.

Product Characteristics

- Available in custom lengths 150mm-3000mm (1-10ft.)
- Optic designed to ensure uniform light diffusion
- Recessed installation with fixing springs (included)
- Available in 3000K, 4000K, 5000K and Emotion (additional color temperatures available on request)
- Change color temperature (WW to CW) with Emotion Technology
- Attached 3m (10ft.) cord 24 AWG, disconnectable at 60mm

Suitable Applications

- Retail Displays
- Casework
- Cabinet Interiors
- Shelving

Specifications

	112 LED/m	160 LED/m	EMOTION
L	150-3000mm (1-10ft.)	150-3000mm (1-10ft.)	150-3000mm (1-10ft.)
Lm	1200lm/m (365lm/ft.)	1950lm/m (594lm/ft.)	1170lm/m (357lm/ft.)
W	8W/m (2.4W/ft.)	13W/m (4W/ft.)	13W/m (4W/ft.)
Max 18W Driver	2.2m (7ft.)	1.4m (5ft.)	1.4m (5ft.)
Max 36W Driver	4.5m (15ft.)	2.8m (9ft.)	2.8m (9ft.)
Max 48W Driver	6m (20ft.)	3.7m (12ft.)	3.7m (12ft.)
Max 72W Driver	9m (29ft.)	5.5m (18ft.)	5.5m (18ft.)
Max 90W Driver	11.2m (37ft.)	6.9m (23ft.)	6.9m (23ft.)

Photometrics

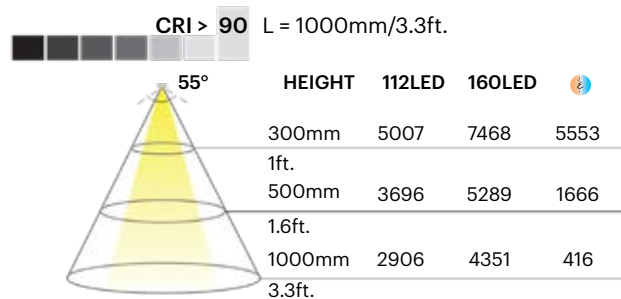

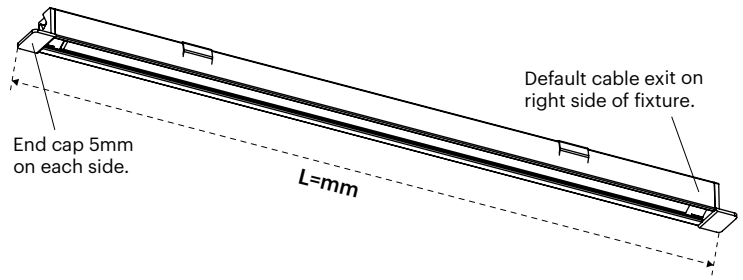
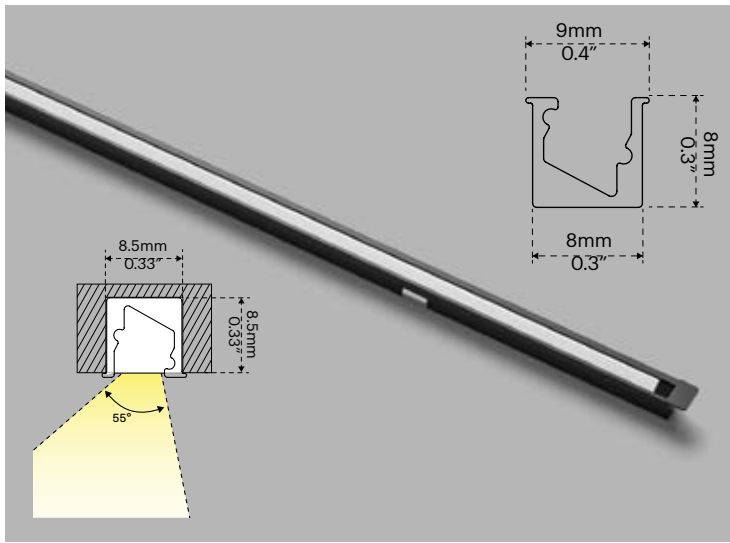

Cord Specifications

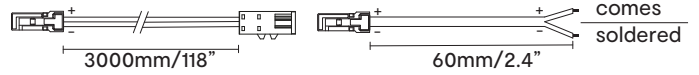

Mini Noor

24V / 112 LED/m

Item Code	L (mm)	L (ft)	Wattage	Kelvin	Lumen
2004230	150-3000mm	1-10ft.	8W/m (2.4W/ft.)	3000K	1200lm/m (365lm/ft.)
2004240				4000K	
590600006				5000K	

Additional color temperatures (CCT) are available on request. Expected lead time 4 weeks + shipping.

Additional Accessories

Item Code	Accessories	L (mm)	L (ft)
1540602	Extension Cords for light fixture (Fixture to Driver & Fixture to Fixture)	250mm	1ft.
1540702		500mm	2ft.
1540802		1000mm	3ft.
1540902		2000mm	7ft.

Mini Noor

24V / 160 LED/m

Item Code	L (mm)	L (ft)	Wattage	Kelvin	Lumen
590600007	150-3000mm	1-10ft.	13W/m (4W/ft.)	3000K	1950lm/m (594lm/ft.)
2009240				4000K	
590600008				5000K	

Additional color temperatures (CCT) are available on request. Expected lead time 4 weeks + shipping.

Power Supplies

24V

Product Details	Wattage
MEC Driver w. Distributor Module More information about the power supplies on page 118.	24V 18W, 36W, 48W, 72W, 90W



Mini Noor

24V / Emotion

Item Code	L (mm)	L (ft)	Wattage	Kelvin	Lumen
2982436	150-3000mm	1-10ft.	13W/m (4W/ft.)	3000K-5000K	1170lm/m (357lm/ft.)
2022226				2700K-6500K	

MALINDI 2



Custom: 150-2500mm



The Malindi 2 has a recessed design which allows it to be mounted perfectly flush with the surface. The lens comes either with an overhang or is flush with the profile. The light output is clean and diode-free.

Product Characteristics

- Available in custom lengths 150mm-2500mm (1-8ft.)
- Available in 3000K, 4000K, and Emotion (additional color temperatures available on request)
- Change color temperature (WW to CW) with Emotion Technology
- CRI >90
- Aluminum heat sink for maximum heat dissipation
- Attached 3m (10ft.) cord 24 AWG, disconnectable at 60mm
- Fixing springs included
- The IN version offers a diffuser that is flush with the profile on all ends

Suitable Applications

- Retail Displays
- Casework
- Cabinet Interiors
- Shelving
- Under Cabinet

Specifications

	112 LED/m	160 LED/m	EMOTION
L	150-2500mm (1-8ft.)	150-2500mm (1-8ft.)	150-2500mm (1-8ft.)
Lm	1200lm/m (365lm/ft.)	1950lm/m (594lm/ft.)	1170lm/m (357lm/ft.)
W	8W/m (2.4W/ft.)	13W/m (4W/ft.)	13W/m (4W/ft.)
Max 18W Driver	2.2m (7ft.)	1.4m (5ft.)	1.4m (5ft.)
Max 36W Driver	4.5m (15ft.)	2.8m (9ft.)	2.8m (9ft.)
Max 48W Driver	6m (20ft.)	3.7m (12ft.)	3.7m (12ft.)
Max 60/72W Driver*	9m (29ft.)	5.5m (18ft.)	5.5m (18ft.)
Max 90W Driver	11.2m (37ft.)	6.9m (23ft.)	6.9m (23ft.)

* 12V lights are only compatible with drivers up to 60W max.

Photometrics

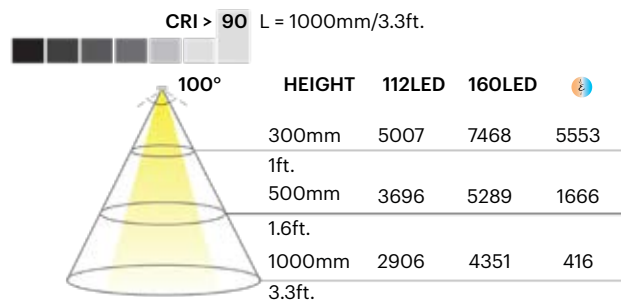

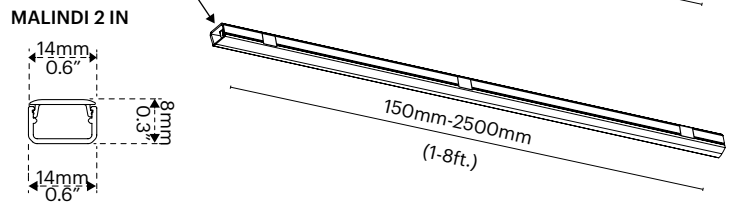
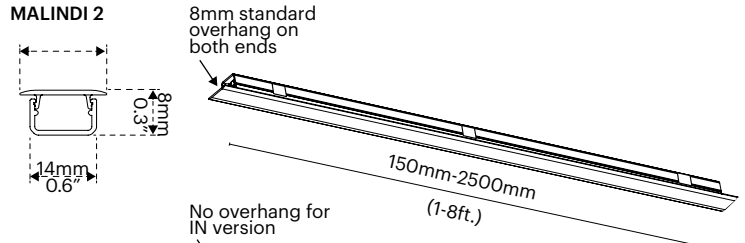
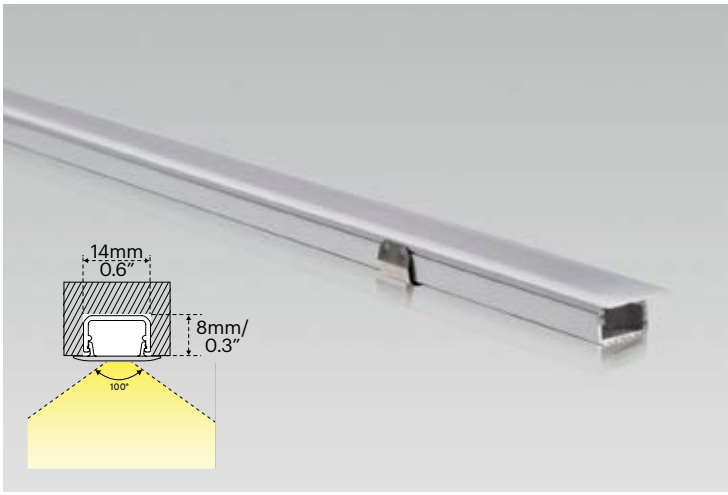

Cord Specifications

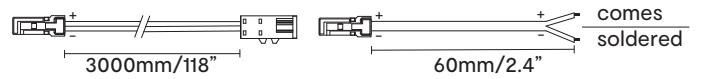

Malindi 2 / IN

12V / 112 LED/m

Item Code	L (mm)	L (ft)	Wattage	Kelvin	Lumen
2017130*	150-2500mm	1-8ft.	11.7W/m (3.6W/ft.)	3000K	1755lm/m (535lm/ft.)
2017140*				4000K	

Additional color temperatures (CCT) are available on request. Expected lead time 4 weeks + shipping.

Malindi 2 / IN

24V / 112 LED/m

Item Code	L (mm)	L (ft)	Wattage	Kelvin	Lumen
2017230	150-2500mm	1-8ft.	8W/m (2.4W/ft.)	3000K	1200lm/m (365lm/ft.)
2017240				4000K	

Additional color temperatures (CCT) are available on request. Expected lead time 4 weeks + shipping.

Malindi 2 / IN

12V / 160 LED/m

Item Code	L (mm)	L (ft)	Wattage	Kelvin	Lumen
2571230*	150-2500mm	1-8ft.	16.9W/m (5.2W/ft.)	3000K	2535lm/m (773lm/ft.)
2861240*				4000K	

Additional color temperatures (CCT) are available on request. Expected lead time 4 weeks + shipping.

Malindi 2 / IN

24V / 160 LED/m

Item Code	L (mm)	L (ft)	Wattage	Kelvin	Lumen
2116130	150-2500mm	1-8ft.	13W/m (4W/ft.)	3000K	1950lm/m (594lm/ft.)
2116140				4000K	

Additional color temperatures (CCT) are available on request. Expected lead time 4 weeks + shipping.

Malindi 2 / IN

Emotion

Item Code / 12V	Item Code / 24V	L (mm)	L (ft)	Wattage	Kelvin	Lumen
2881236	2028235	150-2500mm	1-8ft.	13W/m (4W/ft.)	3000K-5000K	1170lm/m (357lm/ft.)
2591236	2882436				2700K-6500K	

Additional Accessories

Item Code 12V	Item Code 24V	Accessories	L (mm)	L (ft)
1540601	1540602	Extension Cords for light fixture (Fixture to Driver & Fixture to Fixture)	250mm	1ft.
1540701	1540702		500mm	2ft.
1540801	1540802		1000mm	3ft.
1540901	1540902		2000mm	7ft.
2300013	2300013	Magnetic Mounting Kit (2pcs.)		

Power Supplies

12V / 24V

Product Details	Wattage
MEC Driver w. Distributor Module More information about the power supplies on page 118.	12V 18W, 36W, 48W, 60W
	24V 18W, 36W, 48W, 72W, 90W

NOTE: 12V LED lights are only compatible with drivers up to 60W max.

*Extended lead time for 12V 112LED/m and 160 LED/m versions.

MINI KENDO



Custom: 150-3000mm



The Mini Kendo is one of our smallest recessed light fixtures. The slim design adds a very minimalistic look to your application, perfect to create a light output with an stylish appearance.

Product Characteristics

- Available in custom lengths 150mm-3000mm (1-10ft.)
- Available in 3000K, 4000K, and Emotion (additional color temperatures available on request)
- Change color temperature (WW to CW) with Emotion Technology
- CRI >90
- Aluminum heat sink for maximum heat dissipation
- Attached 3m (10ft.) cord 24 AWG, disconnectable at 60mm
- Fixing springs included

Suitable Applications

- Retail Displays
- Casework
- Cabinet Interiors
- Shelving
- Under Cabinet

Specifications

	112 LED/m	160 LED/m	EMOTION
L	150-3000mm (1-10ft.)	150-3000mm (1-10ft.)	150-3000mm (1-10ft.)
Lm	1200lm/m (365lm/ft.)	1950lm/m (594lm/ft.)	1170lm/m (357lm/ft.)
W	8W/m (2.4W/ft.)	13W/m (4W/ft.)	13W/m (4W/ft.)
Max 18W Driver	2.2m (7ft.)	1.4m (5ft.)	1.4m (5ft.)
Max 36W Driver	4.5m (15ft.)	2.8m (9ft.)	2.8m (9ft.)
Max 48W Driver	6m (20ft.)	3.7m (12ft.)	3.7m (12ft.)
Max 72W Driver	9m (29ft.)	5.5m (18ft.)	5.5m (18ft.)
Max 90W Driver	11.2m (37ft.)	6.9m (23ft.)	6.9m (23ft.)

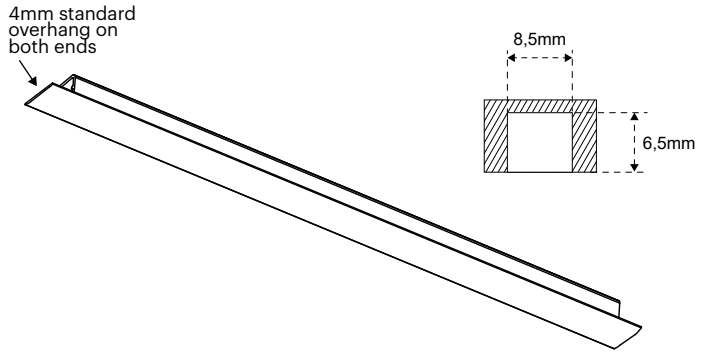
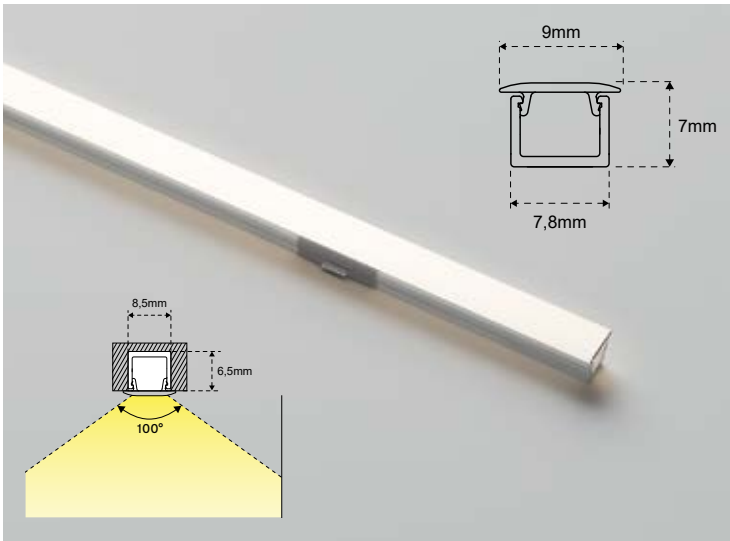

Cord Specifications

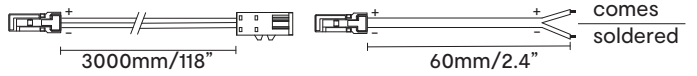

Mini Kendo

24V / 112 LED/m

Item Code	L (mm)	L (ft)	Wattage	Kelvin	Lumen
529300004	150-3000mm	1-10ft.	8W/m (2.4W/ft.)	3000K	1200lm/m (365lm/ft.)
529300001				4000K	
529300005				5000K	

Additional color temperatures (CCT) are available on request. Expected lead time 4 weeks + shipping.

Additional Accessories

Item Code	Accessories	L (mm)	L (ft)
1540602	Extension Cords for light fixture (Fixture to Driver & Fixture to Fixture)	250mm	1ft.
1540702		500mm	2ft.
1540802		1000mm	3ft.
1540902		2000mm	7ft.

Mini Kendo

24V / 160 LED/m

Item Code	L (mm)	L (ft)	Wattage	Kelvin	Lumen
529300008	150-3000mm	1-10ft.	13W/m (4W/ft.)	3000K	1950lm/m (594lm/ft.)
529300013				4000K	
529300009				5000K	

Additional color temperatures (CCT) are available on request. Expected lead time 4 weeks + shipping.

Power Supplies

24V

Product Details	Wattage
MEC Driver w. Distributor Module More informaton about the power supplies on page 118.	24V 18W, 36W, 48W, 72W, 90W



Mini Kendo

24V / Emotion

Item Code	L (mm)	L (ft)	Wattage	Kelvin	Lumen
529300011	150-3000mm	1-10ft.	13W/m (4W/ft.)	3000K-5000K	1365lm/m (420lm/ft.)
529300012				2700K-6500K	

SNITE



Standard lengths

The Snite is the ideal solution for low-cost lighting projects. It offers better performance and a lower price compared to fluorescent lamps, consuming half the energy and lasting more than twice as long. Investing in LED technology will quickly prove cost-effective.

Product Characteristics

- Available in six standard lengths
- High voltage (110-120Vdc), no driver required
- Fixtures are easily linkable via direct or intermediate connectors
- Standard in 3000K and 4000K, other temperatures available on request
- High efficiency with 87lm/W
- Maximum interconnection of 12x 58" fixtures
- Wood mounting kit included
- Optional in-line toggle switch
- Optional magnetic mounting kit

Suitable Applications

- Retail Displays
- Casework
- Cabinet Interiors
- Shelving
- Under Cabinet

Specifications

L	312mm (12")	541mm (21")	573mm (23")	873mm (34")	1173mm (46")	1473mm (58")
Lm	348lm/fx.	609lm/fx.	783lm/fx.	1131lm/fx.	1566lm/fx.	1914lm/fx.
W	4W/fx.	7W/fx.	9W/fx.	13W/fx.	18W/fx.	22W/fx.
Max. Run	66	37	29	20	14	12

Photometrics

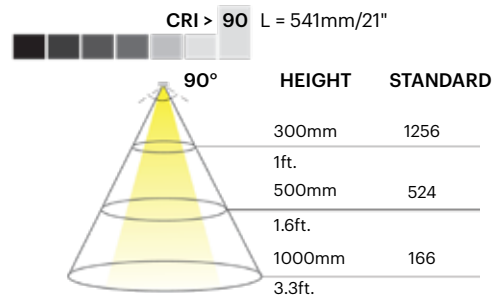

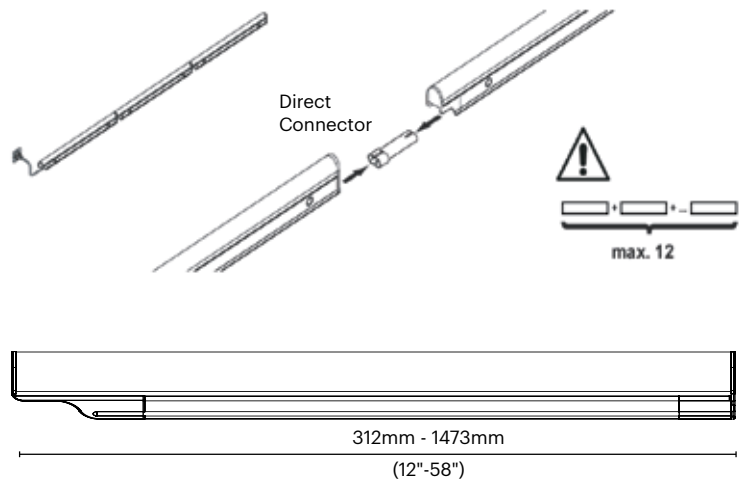
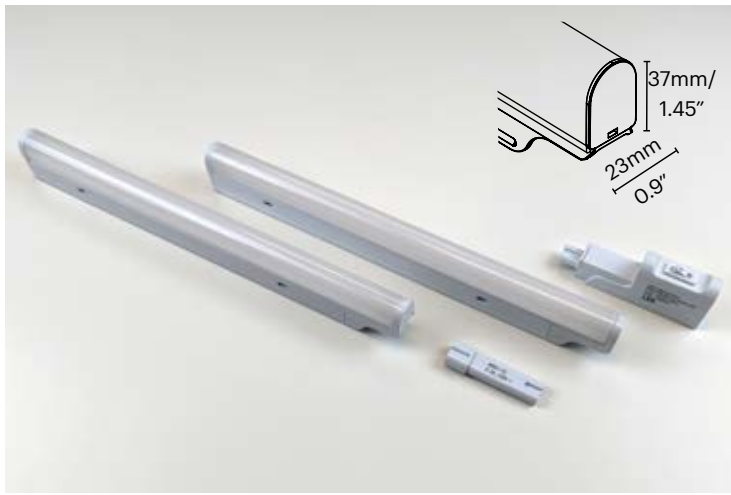

Snite

3000K

Item Code	L (mm)	L (in)	Wattage	Kelvin	Lumen
1305931	312mm	12"	4W/fx.	3000K	348lm/fx.
1305933	541mm	21"	7W/fx.		609lm/fx.
1305934	573mm	23"	9W/fx.		783lm/fx.
1305935	873mm	34"	13W/fx.		1131lm/fx.
1305936	1173mm	46"	18W/fx.		1566lm/fx.
1305937	1473mm	58"	22W/fx.		1914lm/fx.

Additional Accessories

Item Code	Accessories	L (mm)	L (in)
1305917	A - Power Cord	2000mm	79"
1305913	B - Power Cord with toggle switch	2000mm	79"
1305912	C - Switch Module (in-line on/off rocker switch)		
1305926	D - Intermediate Connection Cord	300mm	12"
1305929		500mm	20"
1305932		1000mm	39"
1305911	E - Direct Connector (connects from fixture to fixture)	50mm	2"
1305910	F - Magnetic Mounting Kit (2pcs.)		

Snite

4000K

Item Code	L (mm)	L (in)	Wattage	Kelvin	Lumen
1305942	312mm	12"	4W/fx.	4000K	348lm/fx.
1305943	541mm	21"	7W/fx.		609lm/fx.
1305944	573mm	23"	9W/fx.		783lm/fx.
1305945	873mm	34"	13W/fx.		1131lm/fx.
1305946	1173mm	46"	18W/fx.		1566lm/fx.
1305947	1473mm	58"	22W/fx.		1914lm/fx.

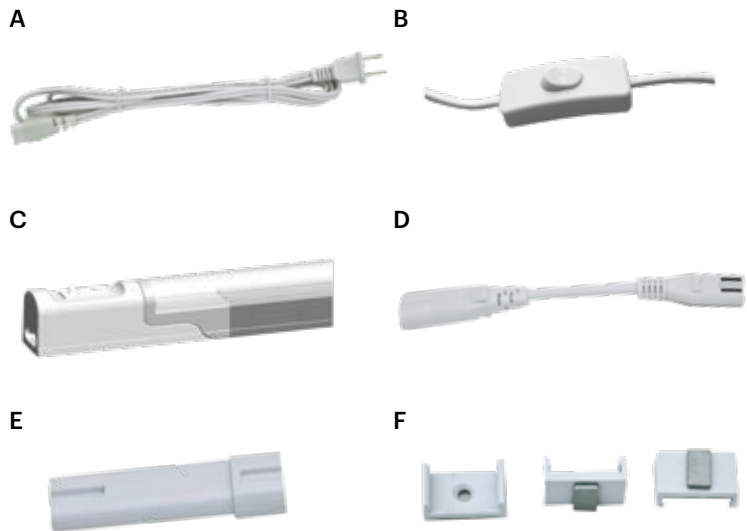

SNITE PRO



Standard lengths

The Snite Pro is a robust and efficient LED light that easily replaces fluorescent lamps thanks to the grounded 3-prong power connection. It uses less energy, has a longer lifetime, and maintains its light quality over time.

Product Characteristics

- Available in six standard lengths
- High voltage (110-120Vdc), no driver required
- Fixtures are easily linkable via connectors
- Standard in 3000K and 4000K
- High efficiency with 105lm/W
- CRI 80
- 3-prong power connection, ideal to replace old fluorescent lamps
- Maximum interconnection of 15x 56" (total: 21m/70ft.) fixtures
- Certified for: Food Equipment, NSF/ANSI 2:2021
- Wood mounting kit included

Suitable Applications

- Retail Displays
- Cabinet Interiors
- Under Cabinet
- Casework
- Shelving

Specifications

L	280mm (11")	457mm (18")	538mm (21")	838mm (33")	1138mm (44")	1438mm (56")
Lm	420lm/fx.	735lm/fx.	840lm/fx.	1260lm/fx.	1680lm/fx.	2100lm/fx.
W	4W/fx.	7W/fx.	8W/fx.	12W/fx.	16W/fx.	20W/fx.
Max. Run	75	42	37	23	18	15

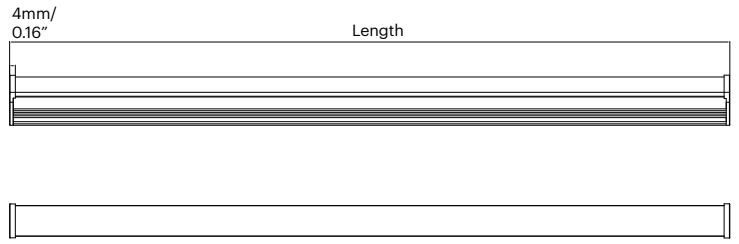
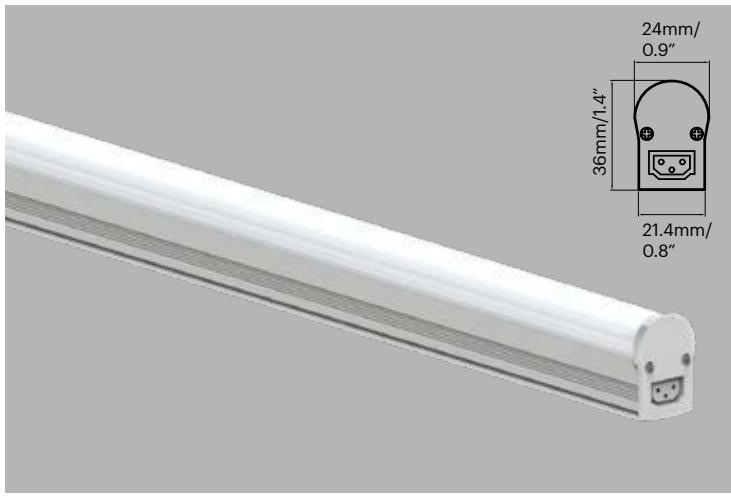

Snite Pro

3000K

Item Code	L (mm)	L (in)	Wattage	Kelvin	Lumen
1307301-01	280mm	11"	4W	3000K	420lm
On request	457mm	18"	7W		735lm
1307302-01	538mm	21"	8W		840lm
1307303-01	838mm	33"	12W		1260lm
1307304-01	1138mm	44"	16W		1680lm
1307305-01	1422mm	56"	20W		2100lm

Additional Accessories

Item Code	Accessories	L (mm)	L (in)
1306610	A - Input Cable	2000mm	79"
1306611	B - Connection Cord	300mm	12"
1306612	C - Corner Connection Cord	300mm	12"
1306001	Magnetic Mounting Kit (2pcs.)		

Snite Pro

4000K

Item Code	L (mm)	L (in)	Wattage	Kelvin	Lumen
1306400-01	280mm	11"	4W	4000K	420lm
1306405-01	457mm	18"	7W		735lm
1306401-01	538mm	21"	8W		840lm
1306402-01	838mm	33"	12W		1260lm
1306403-01	1138mm	44"	16W		1680lm
516600001	1422mm	56"	20W		2100lm

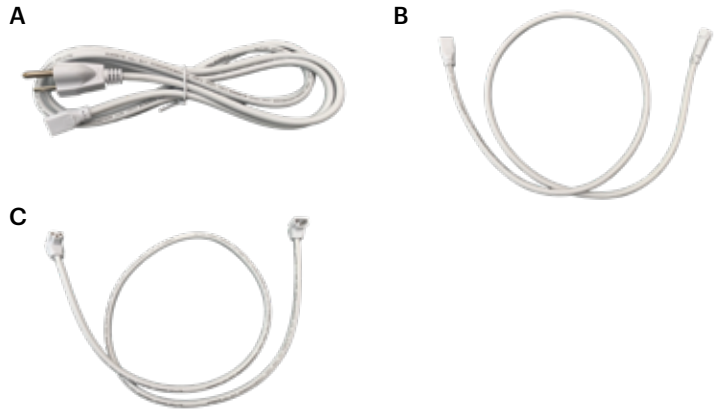

KITON



Custom: 200-2500mm



The Kiton provides convenient lighting for kitchen drawers and cabinets. The integrated sensor softly switches the light on and off when a door is opened or closed. The fixture is available in custom size.

Product Characteristics

- Comes in six standard lengths as well as custom lengths available
- Integrated IR sensor: 1 sensor version for drawers or single doors, 2 sensor version for double doors
- Change color temperature (WW to CW) with Emotion Technology
- Soft Start Sensor technology turns light on gradually 0-100% in ~1 sec.
- CRI >90
- Attached 2m (6.6ft.) cord 24 AWG (attached to sensor)
- Mounts with included accessories on side walls of cabinet. This allows installation in multiple drawers

Suitable Applications

- Cabinet Interiors
- Drawer Cabinets

Specifications

	3000K, 4000K, Emotion
L	200-2500mm
W	13W/m (4W/ft.)
Max 18W Driver	1.3m (4.2ft.)
Max 36W Driver	2.7m (8.8ft.)
Max 48W Driver	3.7m (12.1ft.)
Max 60W Driver	4.6m (15ft.)

Photometrics

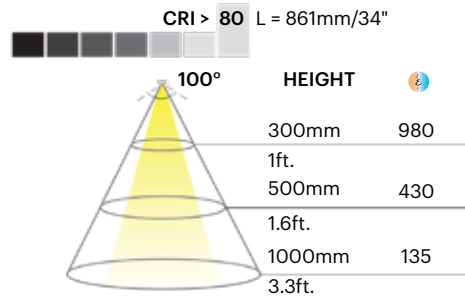

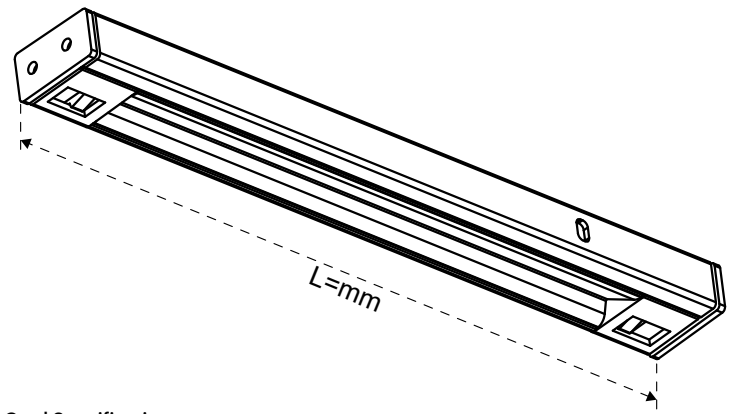
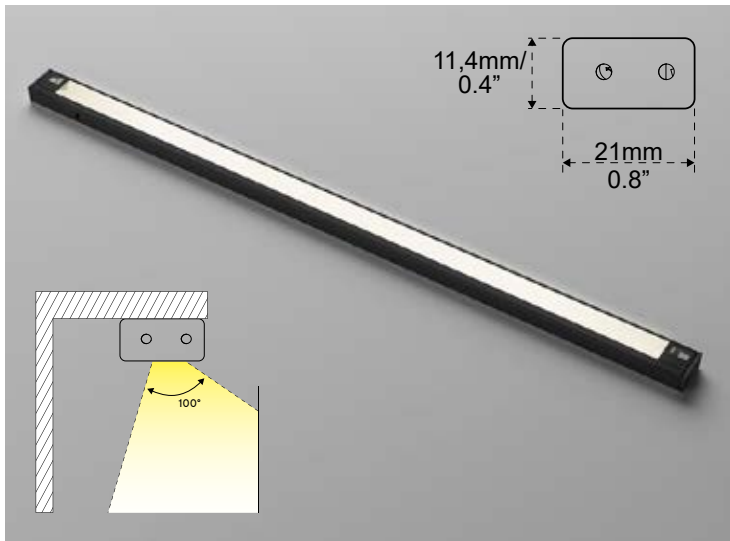

Cord Specifications

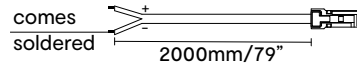

Kiton

12V / 1 Sensor

Item Code	L (mm)	L (in)	Wattage	Kelvin*
2010130	200-2500mm	1-8ft.	13W/m (4W/ft.)	3000K
2010140				4000K

Kiton

12V / 2 Sensors

Item Code	L (mm)	L (in)	Wattage	Kelvin*
2010230	200-2500mm	1-8ft.	13W/m (4W/ft.)	3000K
2010240				4000K

*Available in 5000K and 6000K on request.

Kiton

12V / 1 Sensor / Emotion

Item Code	L (mm)	L (in)	Wattage	Kelvin
2010134	200-2500mm	1-8ft.	13W/m (4W/ft.)	3000K-5000K

Kiton

12V / 2 Sensors / Emotion

Item Code	L (mm)	L (in)	Wattage	Kelvin
2015134	200-2500mm	1-8ft.	13W/m (4W/ft.)	3000K-5000K

Additional Accessories

Item Code	Accessories	L (mm)	L (ft)
1540601	Extension Cords for light fixture (Fixture to Driver & Fixture to Fixture)	250mm	1ft.
1540701		500mm	2ft.
1540801		1000mm	3ft.
1540901		2000mm	7ft.

Power Supplies

12V

Product Details	Wattage
<p>MEC Driver w. Distributor Module</p> <p>More informaton about the power supplies on page 118.</p>	<p>12V 18W, 36W, 48W, 60W</p> 

LED Strip Lights

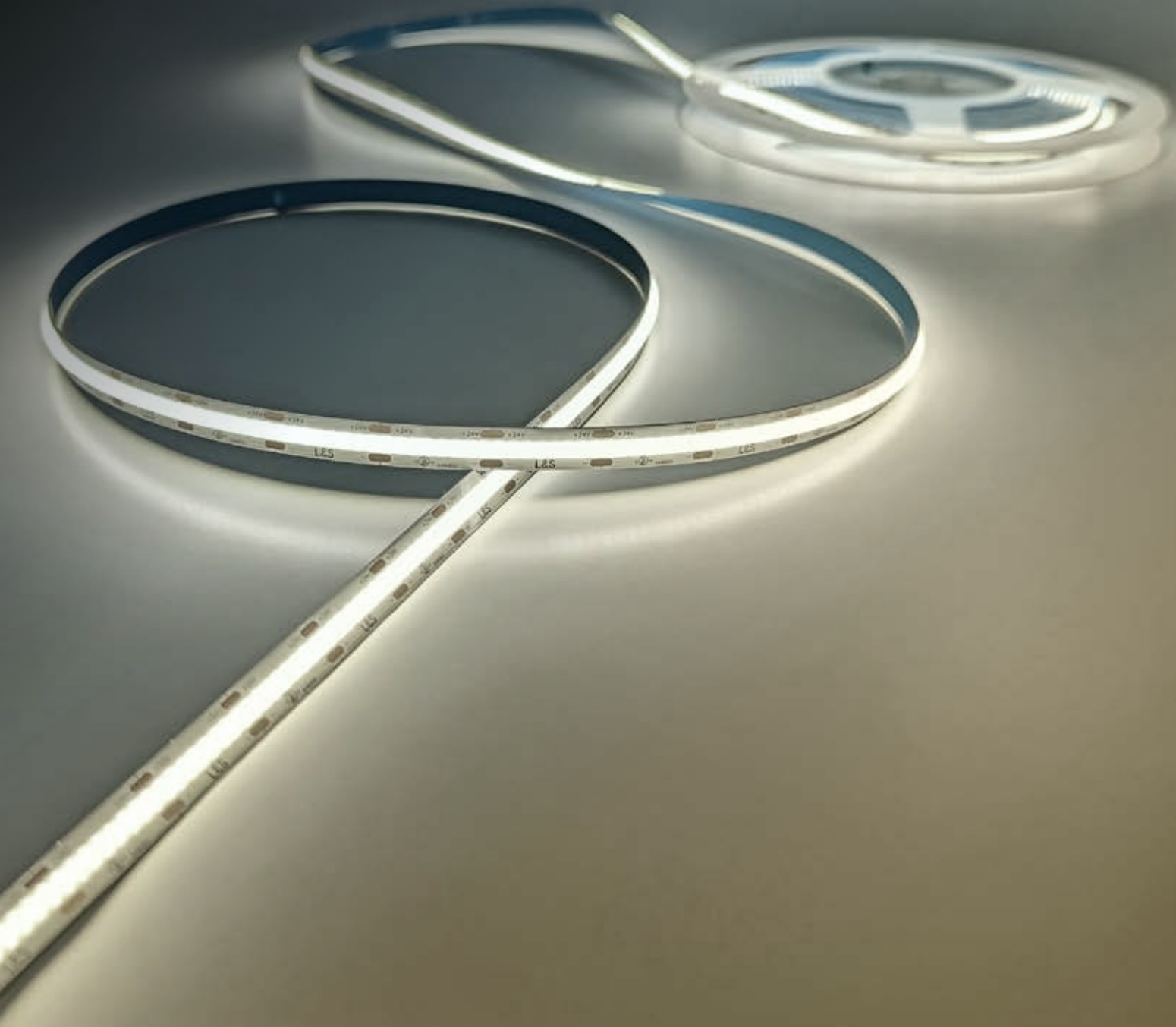

COB LED

—



46
STRIP REEL
COB



47
NEW!
COB FREE-CUT

LED STRIP

—



48
5MM

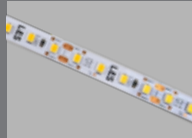

51
8MM



52
10MM

RGB

—

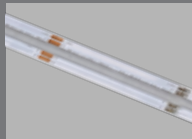

54
COB RGB



54
REGULAR
RGB/RGBW

FLEXIBLE LED STRIP

—

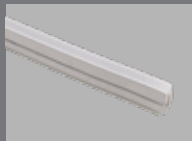

56
MINI
OCTOPUS

STRIP REEL COB



The COB LED Strip delivers smooth, uninterrupted light without needing a lens. Its short cut points make it ideal for tight spaces where channel lights won't fit, and it provides instant diffusion, perfect for lighting reflective surfaces. The new free-cut version features a continuous copper strip, allowing cuts anywhere.

Product Characteristics

- Only 8mm (0.32") wide
- Extremely short cutting points (20mm (0.79") intervals / 25mm (0.98") intervals for 12W vers.), and free-cut (NEW!)
- Available in 7.8W/m, 10W/m, 12W/m and RGB (18W/m)
- Available in 3000K, 3500K, 4000K, 5000K, and 6000K
- CRI 90+
- Very durable, flexible, and low profile
- Diode-free, continuous line of light
- Dimmable
- Adhesive tape for mounting included

Suitable Applications

- Retail Displays
- Cabinet Interiors
- Under Cabinet
- Casework
- Shelving

Specifications

	480 Chip/m	400 Chip/m	640 Chip/m	528 Chip/m
L	5m (16ft.)	5m (16ft.)	5m (16ft.)	5m (16ft.)
Lm	590lm/m (179lm/ft.)	960lm/m (292lm/ft.)	1200lm/m (365lm/ft.)	700lm/m (213lm/ft.)
W	7.8W/m (2.3W/ft.)	10W/m (3W/ft.)	12W/m (3.7W/ft.)	10W/m (3W/ft.)
MAX RUN*	9.2m (30.1ft.)	7.5m (24ft.)	6m (19ft.)	7.2m (24ft.)
Max 18W Driver	2.3m (12.1ft.)	1.8m (6ft.)	1.5m (4ft.)	1.8m (6ft.)
Max 36W Driver	5.9m (19.3ft.)	3.6m (12ft.)	3m (9ft.)	3.6m (12ft.)
Max 48W Driver	6.1m (20ft.)	4.8m (16ft.)	4m (13ft.)	4.8m (16ft.)
Max 72W Driver	9.2m (30.1ft.)	7.2m (24ft.)	6m (19ft.)	7.2m (24ft.)
Max 90W Driver	11.5m (37.7ft.)	9m (30ft.)	7.5m (24ft.)	9m (30ft.)



Strip Reel COB - 7.8W

24V / 480 Chip/m

Item Code	L (m)	L (ft)	Wattage	Kelvin	Lumen
941900319	5m	16ft.	7.8W/m (2.3W/ft.)	3000K	590lm/m (179lm/ft.)
941900419				4000K	
941900420				5000K	628lm/m (191lm/ft.)
941900421				6000K	649lm/m (198lm/ft.)

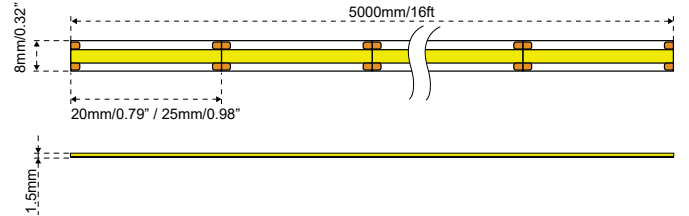
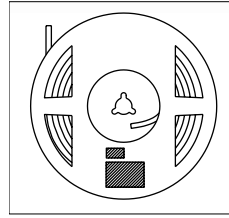

Strip Reel COB - 10W

24V / 400 Chip/m

Item Code	L (m)	L (ft)	Wattage	Kelvin	Lumen	
941900229	5m	16ft.	10W/m (3W/ft.)	3000K	960lm/m (292lm/ft.)	
3502435				3500k		
3502440				4000K		
941900805				5000K		1008lm/m (307lm/ft.)
3502460				6000K		1056lm/m (321lm/ft.)

Connection Cords

Strip Reel COB

Item Code	Accessories	L (mm)	L (ft)
3002481	A - Input Clip Connector	100mm	0.3ft.
3002482		2000mm	7ft.
3002483	B - Connection Clip Cable	25mm	0.08ft.
3002484		300mm	1ft.
3002485		1000mm	3ft.
3002486	C - Direct Connection Clip	Direct	

Strip Reel COB - 12W

24V / 640 Chip/m

Item Code	L (m)	L (ft)	Wattage	Kelvin	Lumen
3702430	5m	16ft.	12W/m (3.7W/ft.)	3000K	1200lm/m (365lm/ft.)
3702435				3500k	
3702440				4000K	
3702460				6000K	



Transparent connector. Create a continuous light stream (no dark spot)

NEW! Strip COB Free Cut

Strip Reel COB - Free Cut

24V / 528 Chip/m

Item Code	L (m)	L (ft)	Wattage	Kelvin	Lumen
941900925	5m	16ft.	10W/m (3W/ft.)	3000K	650lm/m (198lm/ft.)
941900926				4000k	700lm/m (213lm/ft.)
941900927				5000K	700lm/m (213lm/ft.)



This new LED strip features continuous copper, enabling unrestricted cutting points - it can be cut anywhere.

LED STRIP 5MM / 8MM



The 5mm and 8mm LED Strip is thin, efficient, and bright with a "peel and stick" backing and flexible material for any application. The clip-on connectors provide a secure connection.

Product Characteristics

- Available in 5m Reels (16ft.)
- Exceptional efficiency in a compact 5mm and 8mm width
- Standard in 3000K, 3500K, 4000K, 5000K, and 6000K
- Available in Emotion 3000K-5000K and 2700K-6500K
- Adhesive tape for mounting included

Suitable Applications

- Retail Displays
- Cabinet Interiors
- Under Cabinet
- Casework
- Shelving



Specifications**

	112LEDs/m	160LEDs/m	EMOTION	280LED/m PRIMO
L	5m (16ft.)	5m (16ft.)	5m (16ft.)	5m (16ft.)
Lm	1200lm/m (365lm/ft.)	1950lm/m (594lm/ft.)	1170lm/m (357lm/ft.)	1640lm/m (500lm/ft.)
W	8W/m (2.4W/ft.)	13W/m (4W/ft.)	13W/m (4W/ft.)	16.4W/m (5W/ft.)
MAX RUN*	9m (29ft.)	5.5m (18ft.)	5.5m (18ft.)	4.5m (15ft.)
Max 18W Driver	2.2m (7ft.)	1.4m (5ft.)	1.4m (5ft.)	1.1m (4ft.)
Max 36W Driver	4.5m (15ft.)	2.8m (9ft.)	2.8m (9ft.)	2.2m (7ft.)
Max 48W Driver	6m (20ft.)	3.7m (12ft.)	3.7m (12ft.)	3m (10ft.)
Max 72W Driver*	9m (29ft.)	5.5m (18ft.)	5.5m (18ft.)	4.5m (15ft.)
Max 90W Driver*	11.2m (37ft.)	6.9m (23ft.)	6.9m (23ft.)	5.6m (18ft.)

*24V only

**Specifications for 24V, 5mm tape.

Photometrics

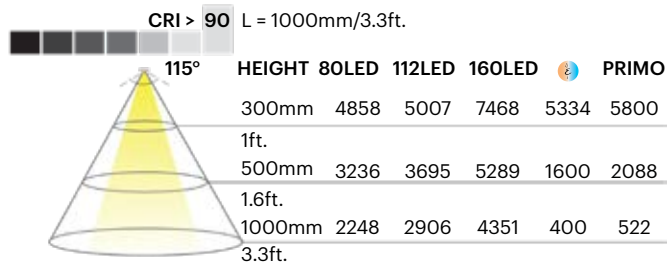

LED Reel / 5mm

12V / 80 LED/m

Item Code*	L (m)	L (ft)	Wattage	Kelvin	Lumen
1108027	5m	16ft.	7.8W/m (2.4W/ft.)	2700K	1170lm/m (357lm/ft.)
1108030				3000K	
1108035				3500K	
1108040				4000K	
1108050				5000K	
1108060				6000K	

Available by special order**

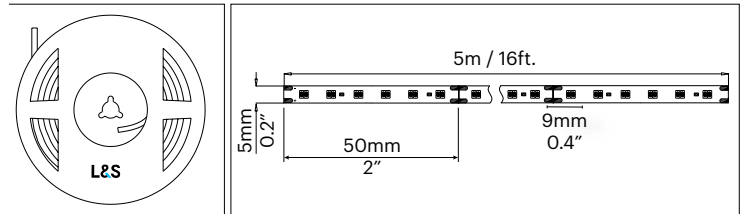

LED Reel / 5mm

12V / 112 LED/m

Item Code*	L (m)	L (ft)	Wattage	Kelvin	Lumen
1111227	5m	16ft.	11.7W/m (3.6W/ft.)	2700K	1755lm/m (535lm/ft.)
1111230				3000K	
1111235				3500K	
1111240				4000K	
1111250				5000K	
1111260				6000K	

Available by special order**

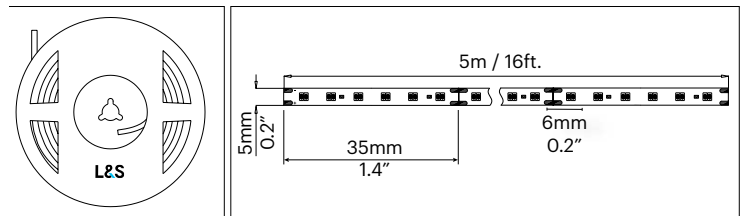

LED Reel / 5mm

12V / 160 LED/m

Item Code*	L (m)	L (ft)	Wattage	Kelvin	Lumen
1116027	5m	16ft.	16.9W/m (5.2W/ft.)	2700K	2535lm/m (773lm/ft.)
1116030				3000K	
1116035				3500K	
1116040				4000K	
1116050				5000K	
1116060				6000K	

Available by special order**

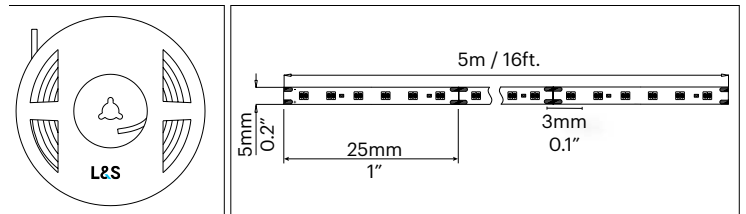

LED Reel Emotion / 5mm

12V / 120+120 LED/m

Item Code*	L (m)	L (ft)	Wattage	Kelvin	Lumen
1124035	10m	32ft.	13W/m (4W/ft.)	3000K- 5000K	1170lm/m (357lm/ft.)
1124026				2700K- 6500K	

Available by special order**

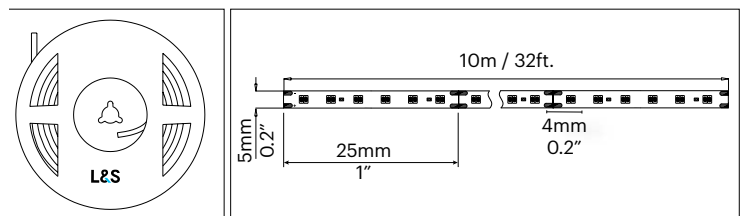

*For custom length add -99 to item code.

**Extended lead times expected for this product. Please contact your sales representative for details.

LED Reel / 5mm

24V / 112 LED/m

Item Code	L (m)	L (ft)	Wattage	Kelvin	Lumen
941900047	5m	16ft.	8W/m (2.4W/ft.)	2700K	1200lm/m (365lm/ft.)
941900010				3000K	
941900049				4000K	
1211250				5000K	
941900016				6000K	

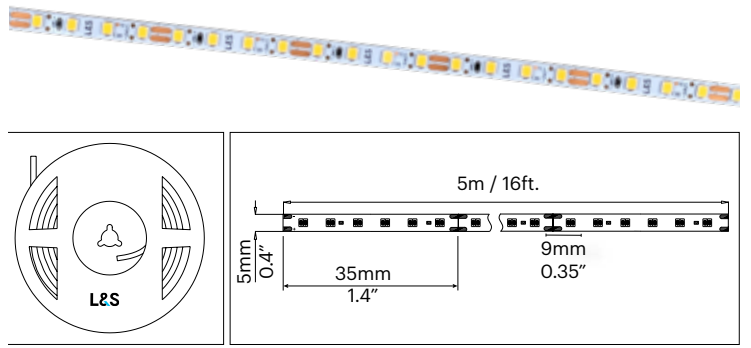

LED Reel / 5mm

24V / 160 LED/m

Item Code	L (m)	L (ft)	Wattage	Kelvin	Lumen
941900053	5m	16ft.	13W/m (3.9W/ft.)	2700K	1950lm/m (594lm/ft.)
941900041				3000K	
941900043				4000K	
941900045				5000K	
941900014				6000K	

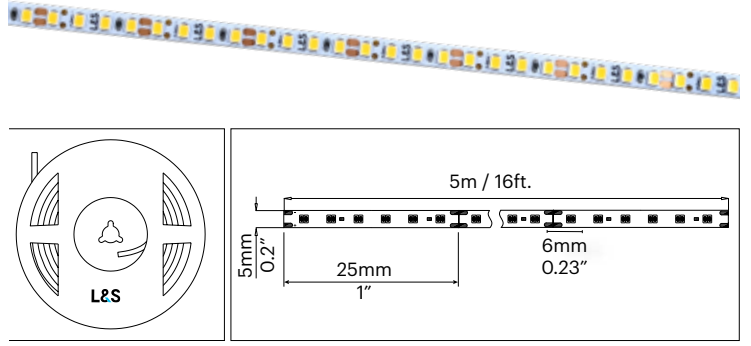

LED Reel Emotion / 5mm

24V / 140+140 LED/m

Item Code*	L (m)	L (ft)	Wattage	Kelvin	Lumen
1124135	10m	32ft.	13W/m (4W/ft.)	3000K-5000K	1170lm/m (357lm/ft.)
1124126				2700K-6500K	

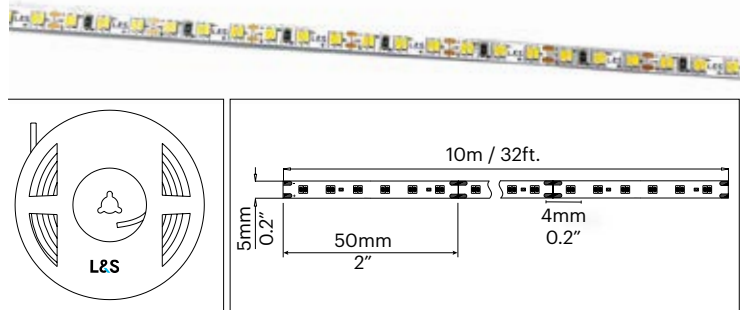

LED Reel Primo / 5mm

24V / 280 LED/m

Item Code*	L (m)	L (ft)	Wattage	Kelvin	Lumen
9110012	5m	16ft.	16.4W/m (5W/ft.)	2700K	1640lm/m (500lm/ft.)
9110013				3000K	
9120014				4000K	
9120015				5000K	

Available by special order**

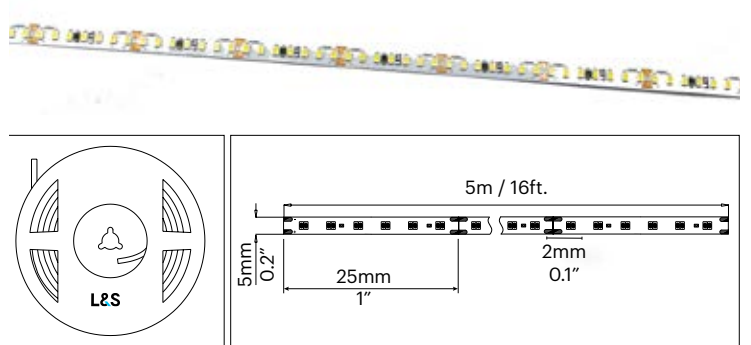

*For custom length add -99 to item code.

**Extended lead times expected for this product. Please contact your sales representative for details.

LED Reel Primo Specifications

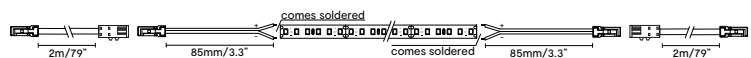

Connection Cords*

12V

Item Code	Accessories	L (mm)	L (ft)
1551210	A - Input Clip Connector	100mm	0.3ft.
1551220		2000mm	7ft.
1551050	B - Connection Clip Cable	50mm	0.2ft.
1551500		500mm	2ft.
1551000		1000mm	3ft.

*Connection cords are not compatible with the 24V Primo LED Reel 280Led/m.

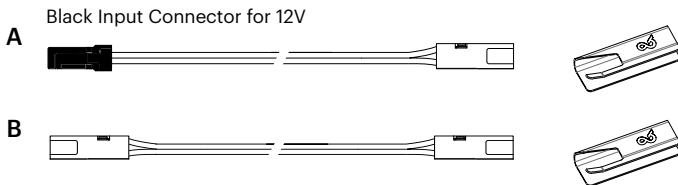

Connection Cords*

24V

Item Code	Accessories	L (mm)	L (ft)
1552410	A - Input Clip Connector	100mm	0.3ft.
1552420		2000mm	7ft.
1551050	B - Connection Clip Cable	50mm	0.2ft.
1551500		500mm	2ft.
1551000		1000mm	3ft.

*Connection cords are not compatible with the 24V Primo LED Reel 280Led/m.

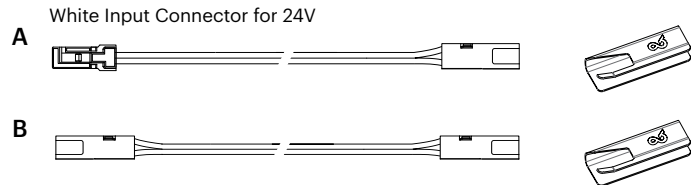

LED STRIP 8MM

LED Reel / 8mm

24V / 112 LED/m

Item Code	L (m)	L (ft)	Wattage	Kelvin	Lumen
1211227	10m	32ft.	8W/m (2.4W/ft.)	2700K	1200lm/m (365lm/ft.)
941900012				3000K	
941900057				4000K	
941900060				5000K	
941900062				6000K	

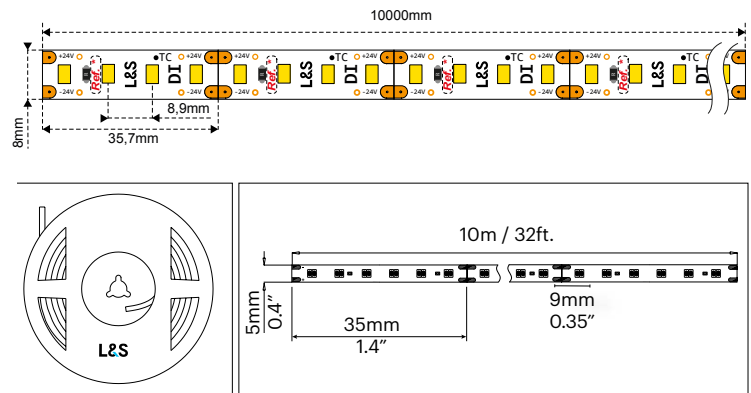

LED Reel / 8mm

24V / 112 LED/m

Item Code	L (m)	L (ft)	Wattage	Kelvin	Lumen
941900339	10m	32ft.	4W/m (1.2W/ft.)	2700K	600lm/m (182lm/ft.)
941900340				3000K	
941900341				4000K	

Connection Cords

24V / 8mm Strip

Item Code	Accessories	L (mm)	L (ft)
753600006	A - Input Clip Connector	2000mm	7ft.
753600007		100mm	0.3ft..
753600008	B - Direct Clip Connector	Direct	
753600009	C - 90° Angled Direct Clip Connector	Direct	.
753600010	D - Open Clip Connector (bare end)		

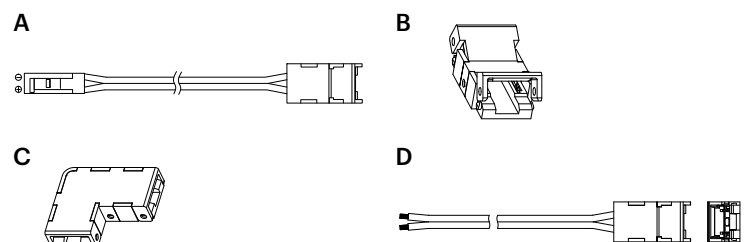

LED STRIP 10MM



The LED Strip is a cost-effective and versatile, with a peel and stick backing and flexible material for easy application. Our Reel Connect System offers a secure connection.

Product Characteristics

- Available in 5m Reel (16ft.)
- Standard in 3000K, 4000K and 6000K
- Extremely reliable and secure
- Ideal for DIY projects - installation w. connection clips, no tools needed
- Adhesive tape for mounting included

Suitable Applications

- Retail Displays
- Cabinet Interiors
- Under Cabinet
- Casework
- Shelving



Specifications

	108LEDs/m	156LEDs/m
L	5m (16ft.)	5m (16ft.)
Lm	1080lm/m (330lm/ft.)	1600lm/m (487lm/ft.)
W	11.7W/m (3.6W/ft.)	16.9W/m (5.2W/ft.)
MAX RUN	5.1m (17ft.)	3.5m (12ft.)
Max 18W Driver	1.5m (5ft.)	1.1m (4ft.)
Max 36W Driver	3.1m (10ft.)	2.1m (7ft.)
Max 48W Driver	4.1m (14ft.)	2.8m (9ft.)
Max 60W Driver	5.1m (17ft.)	3.5m (12ft.)

Photometrics

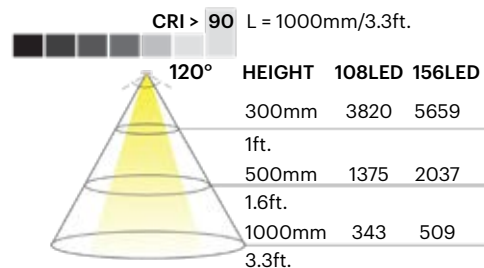

LED Reel

12V / 108 LED/m

Item Code*	L (m)	L (ft)	Wattage	Kelvin	Lumen
1110833	5m	16ft.	11.7W/m (3.6W/ft.)	3000K	1080lm/m (329lm/ft.)
1110844				4000K	

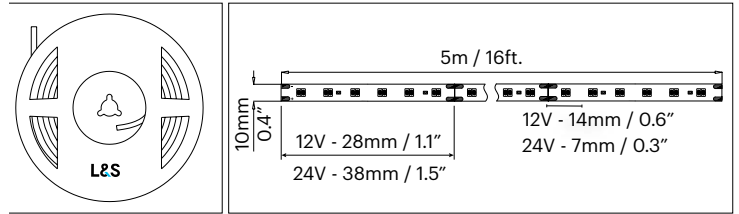

LED Reel

12V / 156 LED/m

Item Code*	L (m)	L (ft)	Wattage	Kelvin	Lumen
1115633	5m	16ft.	16.9W/m (5.2W/ft.)	3000K	1600lm/m (488lm/ft.)
1115644				4000K	
1115666				6000K	

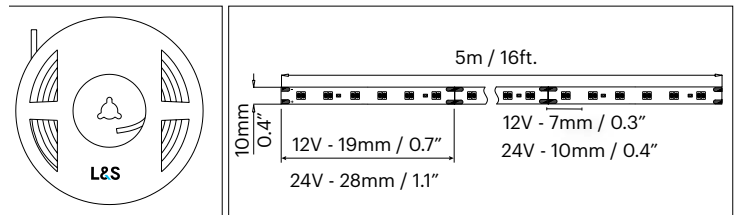

Connection Cords

12V

Item Code	Accessories	L (mm)	L (ft)
1531210	A - Input Clip Connector	100mm	0.3ft.
1531220		2000mm	7ft.
1531050	B - Connection Clip Cable	50mm	0.2ft.
1531500		500mm	2ft.
1531000		1000mm	3ft.
1539312	C - Direct Connection Clip	Direct	

Black Input Connector for 12V

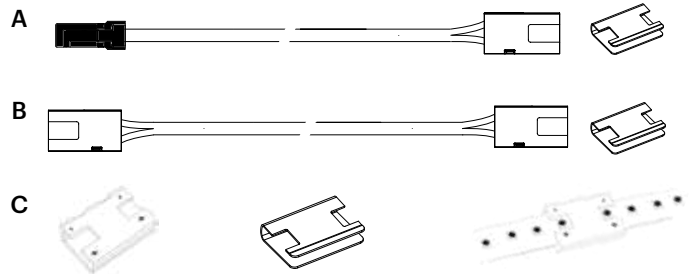

*For custom length add -99 to item code.

For Power Supplies see page 118.

STRIP REEL RGB

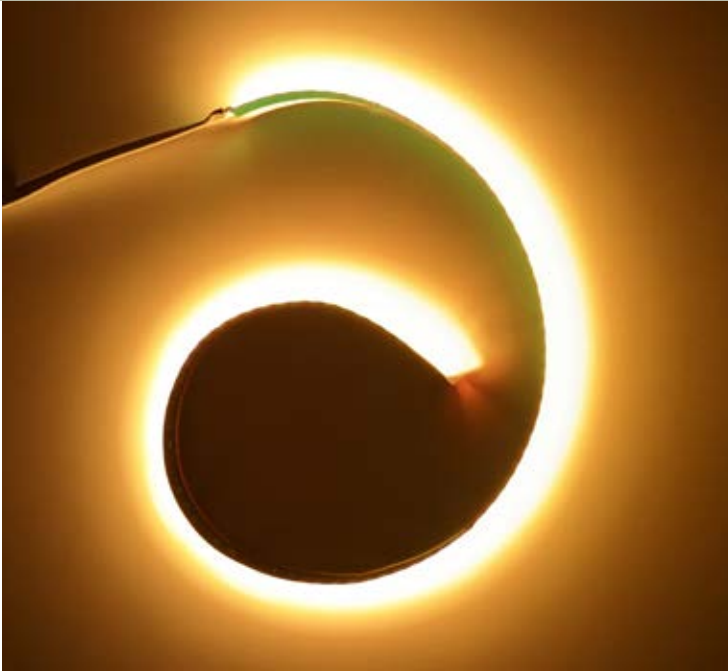

We offer three types of RGB Strips: COB for dot-free colored light, regular RGB strip in red, green, and blue, and RGBW with warm or cold white. All strips work with the L&S RGB controller and app using the L&S MEC Smart System.

Product Characteristics

- Available in 5m Reels (16ft.)
- Available in 24V only
- Diode-free (COB version)
- Perfect for DIY - frequent cut intervals and easy to bend around corners
- Available in 60 LED/m (18LED/ft.) and COB (630 Chip/m / 192 Chip/ft.)
- Adhesive tape for mounting already attached

Suitable Applications

- Retail Displays
- Cabinet Interiors
- Under Cabinet
- Casework
- Shelving

Specifications

	RGB COB Reel	RGB Reel	RGBW Reel
L	5m (16ft.)	5m (16ft.)	5m (16ft.)
Lm	See table on p. 55	590lm/m (180lm/ft.)	1000lm/m (304lm/ft.)
W	15W/m (4.6W/ft.)	14.4W/m (4.3W/ft.)	18.6W/m (5.7W/ft.)
MAX RUN	4.8m (15.7ft.)	5m (16ft.)	3.9m (13ft.)
Max 18W Driver	1.2m (3ft.)	1.3m (4ft.)	0.9m (2.9ft.)
Max 36W Driver	2.4m (7.9ft.)	2.5m (8ft.)	1.9m (6ft.)
Max 48W Driver	3.2m (10.5ft.)	3.3m (11ft.)	2.6m (8ft.)
Max 72W Driver	4.8m (15.7ft.)	5m (16ft.)	3.9m (13ft.)
Max 90W Driver	6m (19.7ft.)	6.3m (21ft.)	4.8m (16ft.)

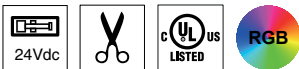
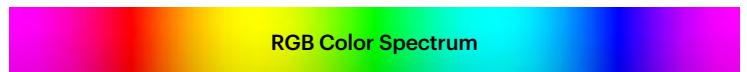

RGB Reel (COB strip)

24V / 630 Chip/m

Item Code*	L (m)	L (ft)	Wattage	Kelvin	Lumen
941902176	5m	16ft.	15W/m (4.6W/ft.)	RGB	R:100lm,G:255lm,B:25 lm/m (R:30,G:78,B:8 lm/ft.)

*For custom length use item code 941902177.

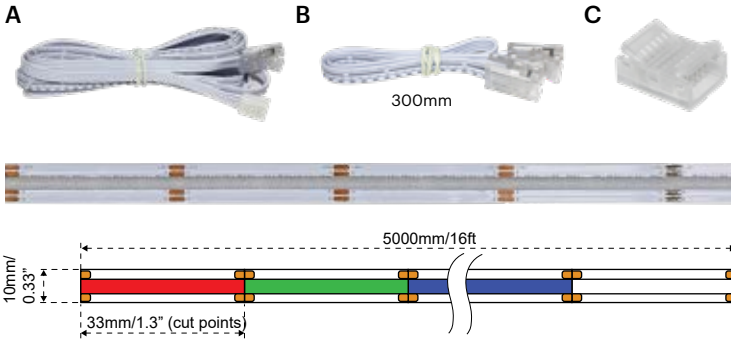

RGB Reel (regular strip)

24V

Item Code*	L (m)	L (ft)	Wattage	Kelvin	Lumen
1100012 ¹	5m	16ft.	14.4W/m (4.3W/ft.)	RGB	590lm/m (180lm/ft.)

*For custom length add -99 to item code.

¹Additional Accessory needed: Connection Cord (A).



RGBW Reel (regular strip)

24V

Item Code*	L (m)	L (ft)	Wattage	Kelvin	Lumen
1110033	5m	16ft.	18.6W/m (5.7W/ft.)	3000K / RGB	1000lm/m (304lm/ft.)
1110034				4000K / RGB	

*For custom length add -99 to item code.

RGB Reel Controllers

More information about remote controllers & the L&S apps on page 125.



Remote
Smart 1 RGB



Remote
Smart 4 RGB



L&S
Mobile App

Connection Cords

COB RGB

Item Code	Accessories	L (mm)	L (ft)
3002491	A - Input Clip Connector	100mm	0.3ft.
3002492		2000mm	7ft.
3002493	B - Connection Clip Cable	25mm	0.08ft.
3002494		300mm	1ft.
3002495		1000mm	3ft.
3002496	C - Direct Connection Clip	Direct	
9150036	RGB Adapter*		

*RGB Adapter already included if ordered with BlueSmart RGB module.

Connection Cords

RGB Reel

Item Code	Accessories	L (mm)	L (ft)
1500051	Input Clip Connector	50mm	0.2ft.
1510016		2000mm	7ft.
1500052	Connection Clip Cable	500mm	2ft.
1500053		1000mm	3ft.
1500016		2000mm	7ft.
1500054	Direct Connection Clip	Direct	
9150036	RGB Adapter*		

*RGB Adapter already included if ordered with BlueSmart RGB module.

Connection Cords

RGBW Reel

Item Code	Accessories	L (mm)	L (ft)
9150044	Connection Clip Cable	25mm	2ft.
9150045		300mm	3ft.
9150046		1000mm	7ft.
9150039	RGB Adapter*		

*RGB Adapter already included if ordered with BlueSmart RGB module.

RGB Reel Connection to Driver

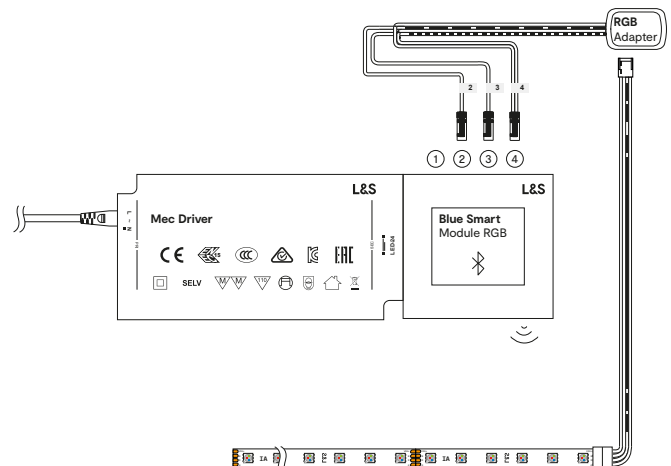

MINI OCTOPUS



The Mini Octopus is a unique LED Strip that bends sideways with a vertical light output. It has maximum flexibility to create a variety of shapes with only 4mm in width, and provides uniform light diffusion with its optics and integrated lens.

Product Characteristics

- Optic designed to ensure uniform light diffusion
- Now available in custom length on request
- Can be cut at dedicated cutting points, every 25mm
- Surface mounted (choose a mounting kit) and recessed installation possible
- Available in 3000K, 4000K and Emotion
- Attached 3m (10ft.) cord 24 AWG, disconnectable at 60mm

Suitable Applications

- Signage
- Accent Lighting
- Casework
- Shelving
- Curved Surfaces

Specifications

	Standard 3000K, 4000K		Emotion	
L	3m (10ft.)	6m (20ft.)	3m (10ft.)	6m (20ft.)
Lm	208lm/m (63lm/ft.)	208lm/m (63lm/ft.)	205lm/m (43lm/ft.)	260lm/m (43lm/ft.)
W	8W/m (2.4W/ft.)	8W/m (2.4W/ft.)	10W/m (3.1W/ft.)	10W/m (3.1W/ft.)
Max 18W Driver	2.5m (8ft.)	2.5m (8ft.)	1.8m (6ft.)	1.8m (6ft.)
Max 36W Driver	4.5m (15ft.)	4.5m (15ft.)	3.6m (12ft.)	3.6m (12ft.)
Max 48W Driver	6m (20ft.)	6m (20ft.)	4.8m (16ft.)	4.8m (16ft.)
Max 72W Driver	9m (30ft.)	9m (30ft.)	7.2m (24ft.)	7.2m (24ft.)
Max 90W Driver	11.3m (37ft.)	11.3m (37ft.)	9m (30ft.)	9m (30ft.)

Photometrics

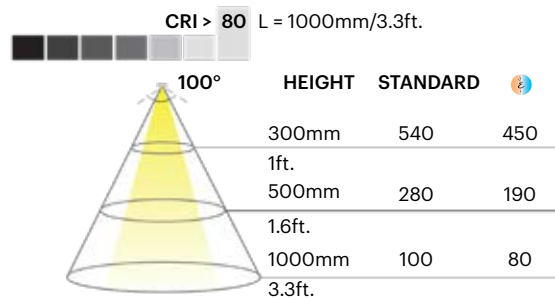

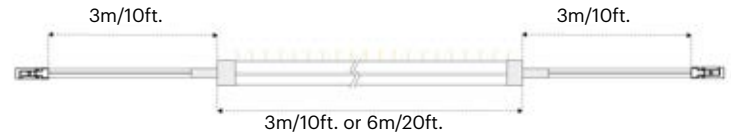
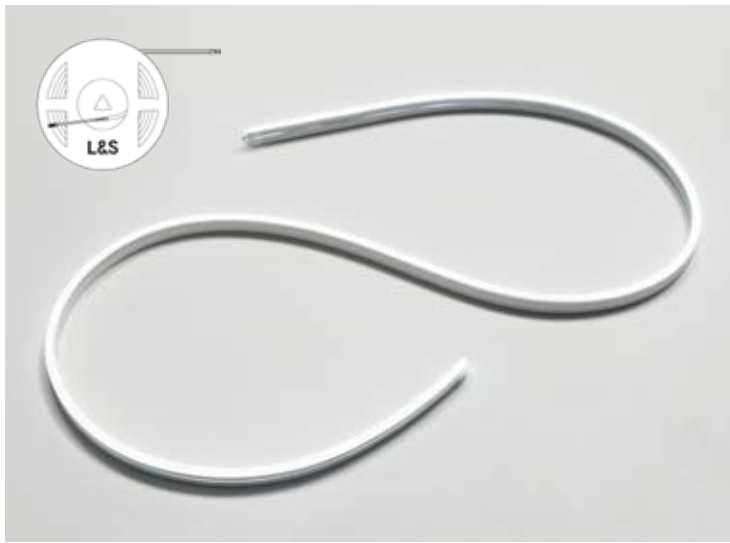

Connection Cord
L= 3m / 10ft.

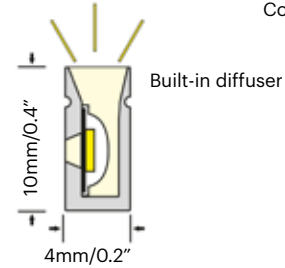

Mini Octopus

24V / Standard

Item Code	L (mm)	L (ft)	Wattage	Kelvin	Lumen
941900235	3000mm	10ft.	8W/m (2.4W/ft.)	3000K	208lm/m (63lm/ft.)
941900236				4000K	
941900451	6000mm	20ft.		3000K	
941900452				4000K	

Additional Accessories

Item Code	Accessories	Surface
2300019	A - Surface Mounting Kit - vertical light output (suggested 1 kit per 10ft. roll)	Wood
2300020	B - Recessed Mounting Kit - horizontal light output (suggested 1 kit per 10ft. roll)	Wood
753800579	End caps	



Mini Octopus

24V / Emotion

Item Code	L (mm)	L (ft)	Wattage	Kelvin	Lumen
1102434*	3000mm	10ft.	10W/m (3.1W/ft.)	3000K-4000K	205lm/m (43lm/ft.)
941901432	6000mm	20ft.		3000K-4000K	260lm/m (43lm/ft.)

*For custom length add -99 to item code.

Additional Accessories

Item Code	Accessories	L (mm)	L (ft)
1540602	Extension Cords (Fixture to Driver & Fixture to Fixture)	250mm	1ft.
1540702		500mm	2ft.
1540802		1000mm	3ft.
1540902		2000mm	7ft.

Power Supplies

24V

Product Details	Wattage
MEC Driver w. Distributor Module More informaton about the power supplies on page 118.	24V 18W, 36W, 48W, 72W, 90W



MEC Professional



MEC
PROFESSIONAL
—

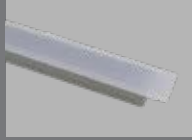

60

MEC MALINDI



61

MICRO MEC-3



62

MEC CORNER



62

MEC QUATTRO



63

MEC RACK

NUBIO
—



64

COUNTERTOP
ILLUMINATION
—



65

SLIM COVER
DIFFUSER
—



65

MEC MALINDI

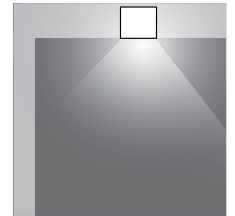
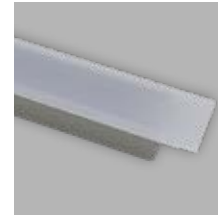
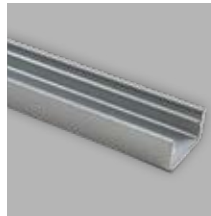
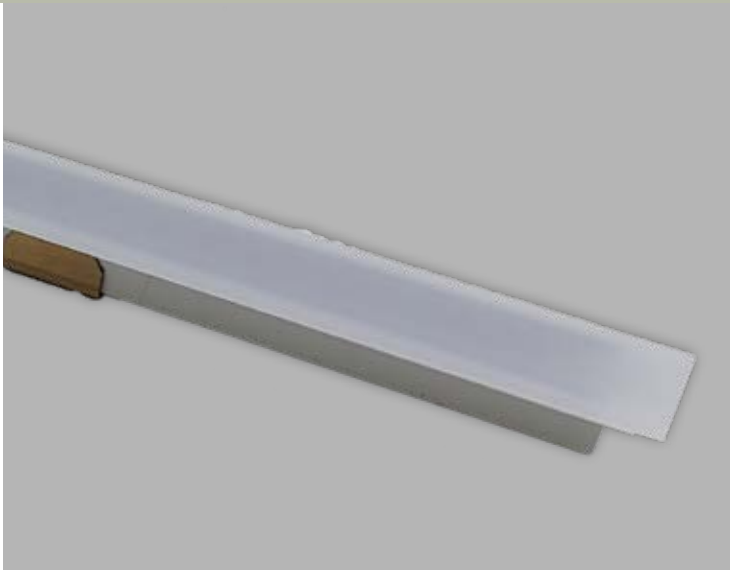

Create your custom lighting system with MEC Professional Kits - easy to install, no soldering required.



Product Characteristics

- Flat aluminium profile for recessed installation with opaque lens
- Symmetrical light distribution
- Aluminum finish

Order by part or already assembled! Contact your sales rep for customized orders.

MEC Malindi Kit

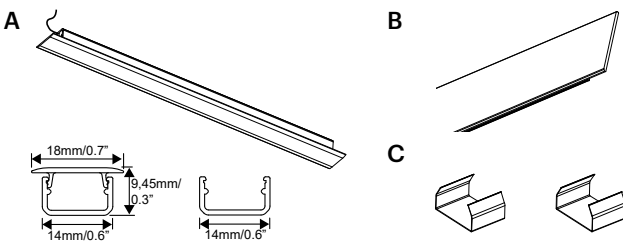

Flat / Recessed

Item Code	Description	L (mm)	L (ft)	Finish
5381030	A - Flat, Recessed Profile	2500mm	8ft.	Aluminum
	B - Opaque Lens			
2300029	Fixing Springs (2pcs./500mm)			Aluminum



Lighting & Accessories

12V / 24V

Product Details	Wattage / Voltage
LED Reel 5mm More information on page 48-51.	12V / 24V 80LED/m, 112LED/m, 160LED/m, 120+120LED/m 
Connection Cords More information on page 48-51.	12V / 24V Input Clip Connector, Connection Clip Cable, Direct Connection Clip 
MEC Driver w. Distributor Module More information about the power supplies on page 118.	12V 18W, 36W, 48W, 60W 24V 18W, 36W, 48W, 72W, 90W 

MICRO MEC-3

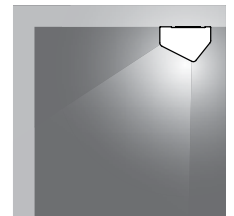

Create your custom lighting system with MEC Professional Kits - easy to install, no soldering required.



Product Characteristics

- Angled aluminium profile for surface installation with opaque lens
- Angled light distribution
- Aluminum or black finish

Order by part or already assembled! Contact your sales rep for customized orders.

Micro MEC-3 Kit

Angled / Surfaced Mounted

Item Code	Description	L (mm)	L (ft)	Finish
5381130	A - Angled, Surface Mounted Profile	2500mm	8ft.	Black
5381330	B - Opaque Lens			Aluminum
2300024	C - End Caps Set (2pcs./fx.)			Black
2300025				Aluminum
2300026	D - Mounting Kit (3pcs./500mm)			

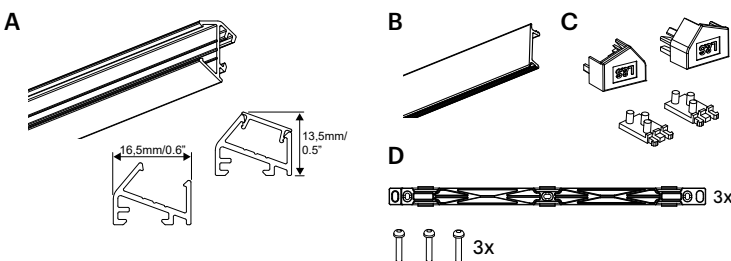

Lighting & Accessories

12V / 24V

Product Details	Wattage / Voltage
LED Reel 5mm More information on page 48-51.	12V / 24V 80LED/m, 112LED/m, 160LED/m, 120+120LED/m
Connection Cords More information on page 48-51.	12V / 24V Input Clip Connector, Connection Clip Cable, Direct Connection Clip
MEC Driver w. Distributor Module More information about the power supplies on page 118.	12V 18W, 36W, 48W, 60W 24V 18W, 36W, 48W, 72W, 90W

MEC CORNER / MEC QUATTRO

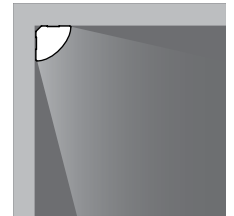

Create your custom lighting system with MEC Professional Kits - easy to install, no soldering required.

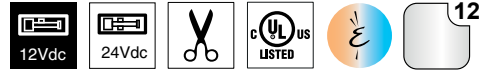

Product Characteristics

- Angled aluminium profile for surface corner installation with opaque lens (rounded or square option)
- Angled light distribution
- Aluminum finish

Order by part or already assembled! Contact your sales rep for customized orders.



MEC Corner Kit

Angled / Surfaced Mounted

Item Code	Type	Description	L (mm)	L (ft)	Finish
5381230	MEC Corner	A - MEC Corner - Angled, Surface Mounted Profile B - Opaque Lens	2500mm	8ft.	Aluminum
60090072	MEC Quattro				
2300027-01	MEC Corner	C - End Caps Set (2pcs./fx., comes with input cable already attached)			Aluminum
60090073	MEC Quattro				
2300028	MEC Corner	D - Mounting Kit (2pc./500mm)			Aluminum
60080024	MEC Quattro				

Lighting & Accessories

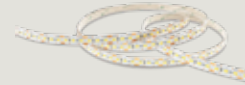
12V / 24V

Product Details	Wattage / Voltage
LED Reel 5mm More information on page 48-51.	12V / 24V 80LED/m, 112LED/m, 160LED/m, 120+120LED/m 
Connection Cords More information on page 48-51.	12V / 24V Input Clip Connector, Connection Clip Cable, Direct Connection Clip 
MEC Driver w. Distributor Module More information about the power supplies on page 118.	12V 18W, 36W, 48W, 60W 24V 18W, 36W, 48W, 72W, 90W 

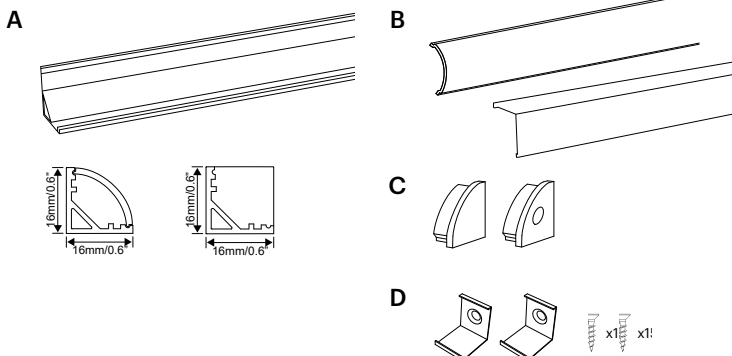

MEC RACK

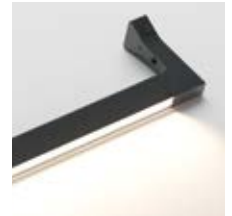
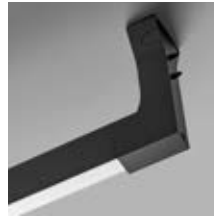
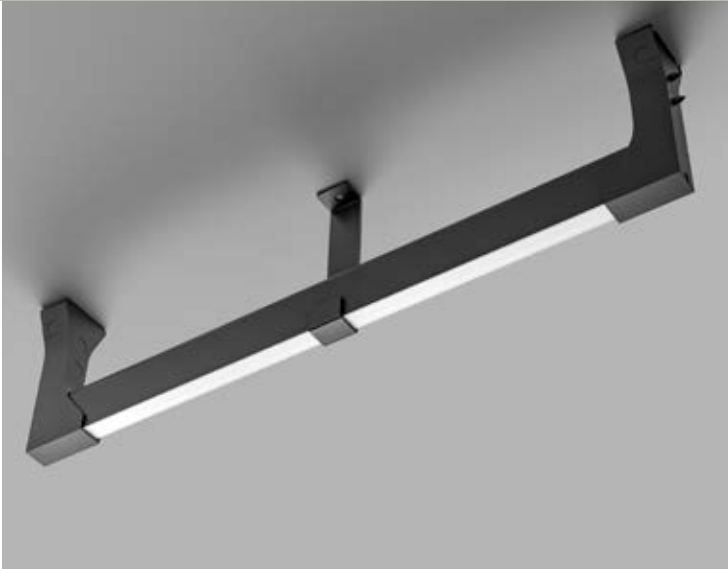

Create your custom lighting system with MEC Professional Kits - easy to install, no soldering required.



Product Characteristics

- For installation in closets, cabinets or under shelves
- Aluminum or black finish
- With optional PIR (motion) sensor built into end cap
- Suggested weight limit 3.3 lb per every 4" (max. 40")

Order by part or already assembled! Contact your sales rep for customized orders.

MEC Rack

Hanging, Surfaced Mounted

Item Code	Description	L (mm)	L (ft)	Finish
3831000	A - Hanging, surfaced mounted Profile	3000mm	10ft.	Black
3832000				Aluminum
3832001	B - Opaque Lens	3000mm	10ft.	
3830001	C - End Cap Set (2pcs./fx.)			Black
3830002				Aluminum
3830003	C - End Cap Set for PIR sensor left (includes Reel connection cable + jumper cable)			Black
3830005				Aluminum
3830006	C - End Cap Set for PIR sensor right (includes Reel connection cable + jumper cable)			Black
3830004				Aluminum
3830007	D - Central Bracket			Black
3830008				Aluminum

Lighting & Accessories

12V / 24V

Product Details	Wattage / Voltage
LED Reel 5mm More information on page 48-51.	12V / 24V 80LED/m, 112LED/m, 160LED/m, 120+120LED/m
Connection Cords More information on page 48-51.	12V / 24V Input Clip Connector, Connection Clip Cable, Direct Connection Clip
MEC Driver w. Distributor Module More information about the power supplies on page 118.	12V 18W, 36W, 48W, 60W 24V 18W, 36W, 48W, 72W, 90W

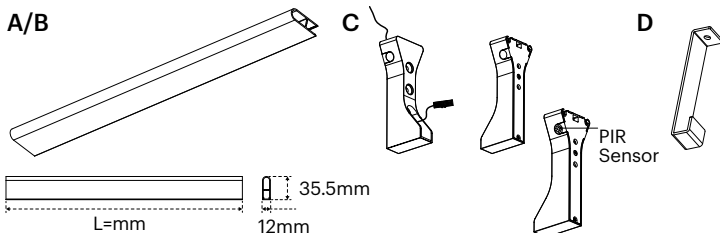

NUBIO

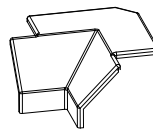
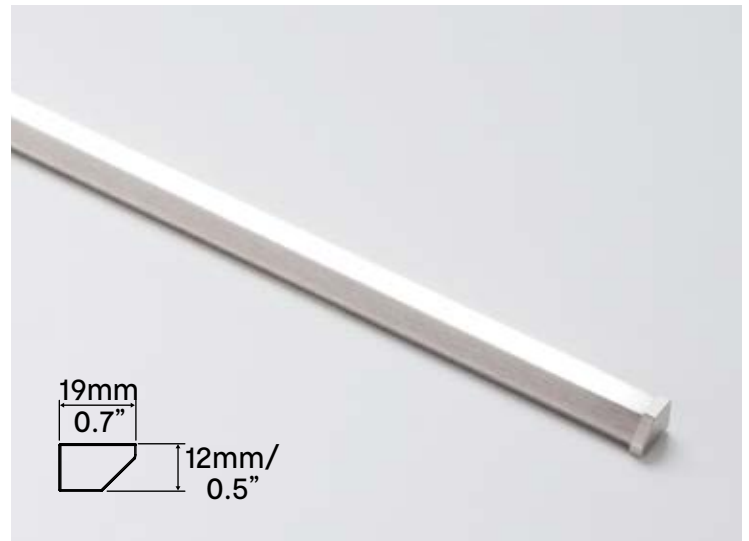

Inner Corner

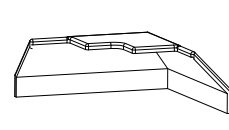

Outer Corner

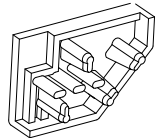

End Caps

Nubio is ideal for accent lighting in kitchens, under countertops, toe kicks, or product displays. Designed for 5mm LED strips, its corner profiles easily follow the edges of countertops or shelves, providing a soft, dot-free lighting effect.

Product Characteristics

- Profile comes in 2500mm standard length
- Compatible with any 5mm LED Strip (see page 48)
- Dot-free accent lighting
- Includes adhesive peel & stick profile and end caps for easy assembly
- CRI >90
- Chrome finish

Suitable Applications

- Retail Displays
- Under countertop lighting
- C/J channel
- Perimeter illumination for mirrors, frames or displays
- Toe kick lighting



Nubio

Item Code	Description	Product Details	L (mm)	L (ft)
1130003	Nubio Profile	Gray/Chrome Finish	2500mm	8ft.
1433620	End Cap Left			
1433621	End Cap Right			
1433624	Outer Corner Set	includes connector and cover		
1433625	Inner Corner Set			

LED Strip

Item Code	Description	Product Details	12V / 24V		
			L (mm)	L (ft)	Kelvin
1124035	LED Reel Emotion	12V, 13W/m (4W/ft.)	5000mm	16ft.	3000K-5000K
1124026					2700K-6500K
1124135		24V, 13W/m (4W/ft.)			3000K-5000K
1124126					2700K-6500K

Find all LED options on page 48.

COUNTERTOP ILLUMINATION (CTI)



Countertop Illumination is a low-voltage lighting system installed between the countertop and cabinets. Its durable aluminum extrusion adds support for the countertop.

Product Characteristics

- Available in 2200mm (7ft.) length
- Opaque lens for a seamless, diode-free appearance
- Compatible with most LED Strips (see page 48)
- Can be mounted horizontally or vertically
- Easy installation
- Aluminum finish

Suitable Applications

- Retail Displays
- Under countertop lighting



Specifications

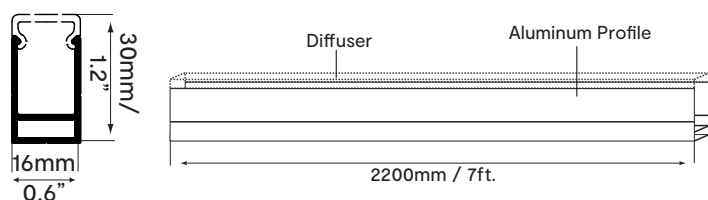

Countertop Illumination (CTI)

Item Code	Description	Product Details	L (mm)	L (ft)
2317755	Profile	Aluminum	2200mm	7ft.
2317709	Diffuser		2200mm	7ft.
1432899	End Cap	1 pc.		

SLIM COVER DIFFUSER



The Slim Cover Diffuser pairs with a recessed LED strip and opaque screen, offering a cost-effective, customizable lighting solution that's easy to cut to size.

Product Characteristics

- Available in 2200mm (7ft.) length
- Opaque lens for a seamless, diode-free appearance
- Compatible with most LED Strips (see page 48)
- Can be mounted horizontally or vertically
- Easy installation

Suitable Applications

- Retail Displays
- Under cabinet
- Shelving
- Recessed applications

Specifications

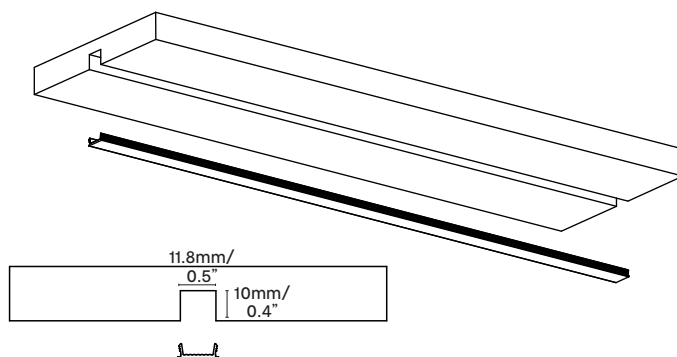

Slim Cover Diffuser

Item Code	Description	L (mm)	L (ft)
1440395	Diffuser Lens	2200mm	7ft.

Spots and Ceiling



RECESSED
SPOTLIGHTS*



68
NUBE*



70
MOONLIGHT*



72
SUPERLIGHT



74
SUPERSPOT

SURFACE
MOUNTED
SPOTLIGHTS



76
TAOS

CEILING
LIGHTS



78
NEW!
DAHLIA



80
NEW!
SAVANNAH

*Surface mounted version via spacer ring available.

NUBE

ALSO AVAILABLE IN 24V



Nube is a compact puck light with a powerful lumen output. Its sleek opaque lens effortlessly spreads an even glow of light. Experience unmatched light efficiency and unbeatable value with this remarkable spotlight.

Product Characteristics

- Opaque lens offering no visible diodes, with diffusion of light
- Available in 3 sizes (35, 58, 68mm)
- Available in 12V and 24V
- Available in 3000K, 4000K and Emotion
- Change color temperature (WW to CW) with Emotion Technology
- CRI >80
- Energy efficient using only 1.3W-3W
- Attached 2m (7ft.) cord
- Can be surface mounted with optional spacer ring
- Available in black and gray finish

Suitable Applications

- Retail Displays
- Cabinet Interiors
- Under Cabinet
- Casework
- Shelving

Specifications

	NUBE 35 12V	NUBE 58 12V	NUBE 68 12V	NUBE 35 24V	NUBE 58 24V	NUBE 68 24V
DIA (Hole)	35mm (1.4")	58mm (2.3")	68mm (2.7")	35mm (1.4")	58mm (2.3")	68mm (2.7")
DIA (Puck)	40mm (1.6")	64mm (2.5")	78mm (3.1")	40mm (1.6")	64mm (2.5")	78mm (3.1")
W	1.8W/ Spot	2.5W/ Spot	3W/ Spot	1.8W/ Spot	2.5W/ Spot	3W/ Spot
Lm	90lm/ Spot	150lm/ Spot	200lm/ Spot	110lm/ Spot	175lm/ Spot	220lm/ Spot
Max 18W Driver	10	7	6	10	6	6
Max 36W Driver	20	14	12	20	12	12
Max 48W Driver	26	19	16	26	16	16
Max 60W /72W Driver*	33	24	20	40	24	20
Max 90W Driver	-	-	-	50	36	30

*72W driver for 24V only.

Photometrics

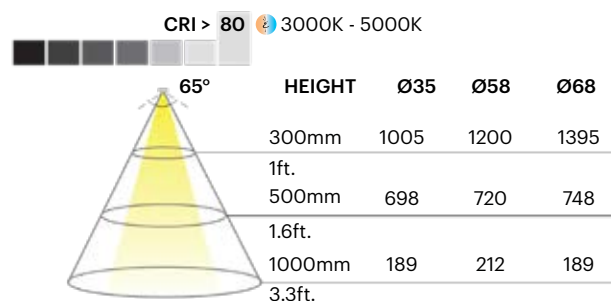

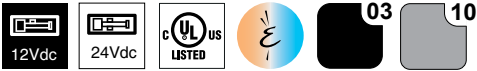
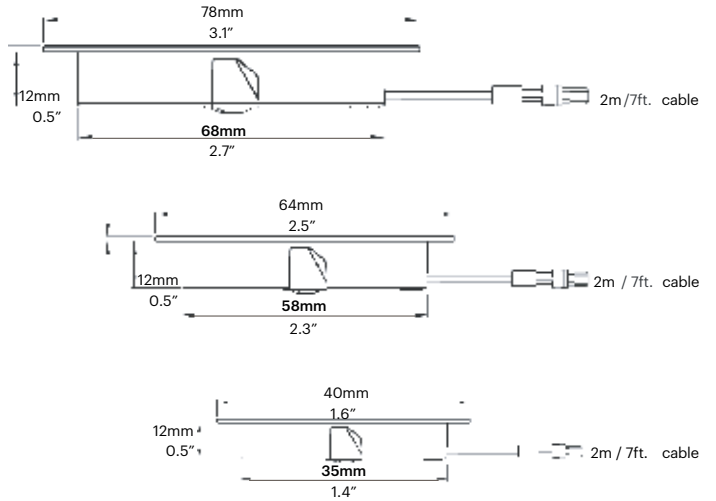
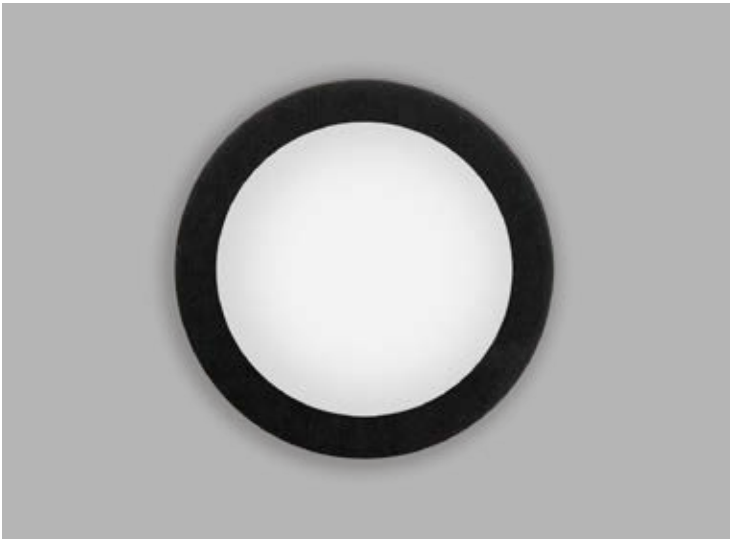

Nube			12V / 35mm			
Item Code	DIA (hole)	DIA (puck)	Wattage	Lumen	Kelvin	Finish
1235385	35mm/1.4"	40mm/1.6"	1.8W/Spot	90lm/Spot	3000K	Stainless Steel
1235485					4000K	
1213535					3000K-5000K	Black
1223535					3000K-5000K	

Nube			24V / 35mm			
Item Code	DIA (hole)	DIA (puck)	Wattage	Lumen	Kelvin	Finish
523300003	35mm/1.4"	40mm/1.6"	1.8W/Spot	110lm/Spot	3000K-4000K	Black
523300002				120lm/Spot		Gray

Available by special order*

Nube			12V / 58mm			
Item Code	DIA (hole)	DIA (puck)	Wattage	Lumen	Kelvin	Finish
1258485	58mm/2.3"	64mm/2.5"	2.5W/Spot	150lm/Spot	4000K	Stainless Steel
1213558					3000K-5000K	Black
1223558					3000K-5000K	Gray

Nube			24V / 58mm			
Item Code	DIA (hole)	DIA (puck)	Wattage	Lumen	Kelvin	Finish
1224558	58mm/2.3"	64mm/2.5"	2.5W/Spot	175lm/Spot	3000K-4000K	Black
523300001				200lm/Spot		Gray

Nube			12V / 68mm			
Item Code	DIA (hole)	DIA (puck)	Wattage	Lumen	Kelvin	Finish
1213568	68mm/2.7"	78mm/3.1"	3W/Spot	200lm/Spot	3000K-5000K	Black
1223568						Gray

Nube			24V / 68mm			
Item Code	DIA (hole)	DIA (puck)	Wattage	Lumen	Kelvin	Finish
523300005	68mm/2.7"	78mm/3.1"	3W/Spot	220lm/Spot	3000K-4000K	Black
523300004				250lm/Spot		Gray

Available by special order*

*Expected lead times 4-6 weeks + shipping. Please contact your sales representative for details.

Spacer Rings

Item Code	DIA (hole)	DIA (puck)	Finish
1223536	35mm/1.4"	40mm/1.6"	Black
1220555	58mm/2.3"	64mm/2.5"	
1223565	68mm/2.7"	78mm/3.1"	
1213536	35mm/1.4"	40mm/1.6"	Gray
1213559	58mm/2.3"	64mm/2.5"	
1213569	68mm/2.7"	78mm/3.1"	

SPACER

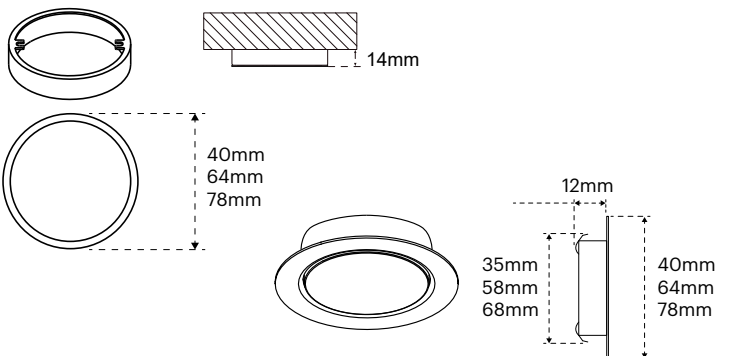

MOONLIGHT



The Moonlight is a highly efficient, recessed spotlight featuring diffused illumination while redirecting the visible diodes to ensure uniform light distribution. The Emotion technology allows you to choose variable color temperatures from WW to CW.

Product Characteristics

- Available in two sizes: 58mm (3W) and 68mm (3.6W)
- Available in Emotion (3000K-6000K)
- Change color temperature (WW to CW) with Emotion Technology
- CRI >80
- Opaque lens offers no visible diodes
- Available in black, gray, and nickel finish
- Attached 2m (7ft.) cord
- Can be surface mounted with optional spacer ring

Suitable Applications

- Retail Displays
- Cabinet Interiors
- Under Cabinet
- Casework
- Shelving

Specifications

	4000K / 6000K / Emotion	
DIA (Hole)	58mm (2.3")	68mm (2.7")
DIA (Puck)	63mm (2.5")	77mm (3")
W	3W/Spot	3.6W/Spot
Lm	180lm/Spot	200lm/Spot
Max 18W Driver	6	5
Max 36W Driver	12	10
Max 48W Driver	16	13
Max 60W Driver	20	16

Photometrics

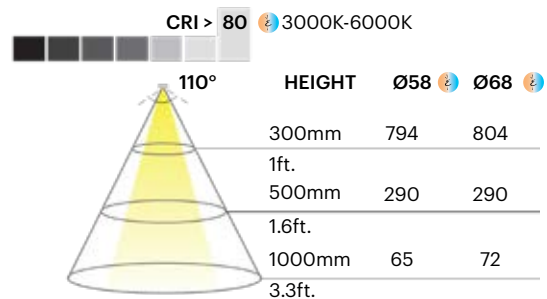

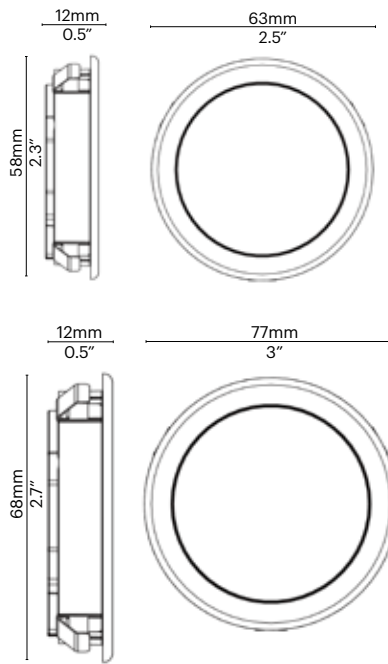

Moonlight

					12V / 58mm	
Item Code	DIA (hole)	DIA (puck)	Wattage	Lumen	Kelvin	Finish
1272265	58mm/2.3"	63mm/2.5"	3W/Spot	180lm/Spot	4000K	Black
1272301						Gray
1272385					6000K	Nickel

Additional Accessories

Item Code	Accessories	L (mm/ft)
1540601	Extension Cords for light fixture (Fixture to Driver & Fixture to Fixture)	250mm / 1ft.
1540701		500mm / 2ft.
1540801		1000mm / 3ft.
1540901		2000mm / 7ft.

Moonlight

					12V / 58mm / Emotion	
Item Code	DIA (hole)	DIA (puck)	Wattage	Lumen	Kelvin	Finish
1200042	58mm/2.3"	63mm/2.5"	3W/Spot	180lm/Spot	3000K-6000K	Black
1200040						Gray

Power Supplies

		12V
Product Details	Wattage	
MEC Driver w. Distributor Module More informaton about power supplies on page 118.	12V 18W, 36W, 48W, 60W	

Moonlight

					12V / 68mm / Emotion	
Item Code	DIA (hole)	DIA (puck)	Wattage	Lumen	Kelvin	Finish
1200045	68mm/2.7"	77mm/3"	3.6W/Spot	200lm/Spot	3000K-6000K	Black
1200043						Gray

Spacer Rings

Item Code	DIA (hole)	DIA (puck)	Finish
1200046	58mm/2.3"	63mm/2.5"	Black
1272565			Gray
1200049	68mm/2.7"	77mm/3"	Black
1200047			Gray

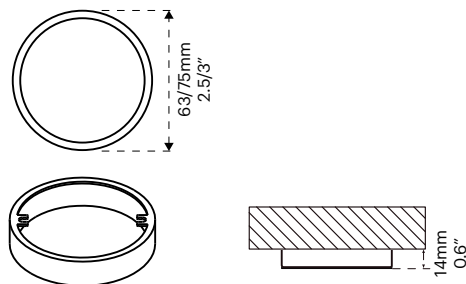

SUPERLIGHT



The Superlight is a round, recessed spotlight featuring a highly polished reflector. Superlight is suitable to light up medium-sized showcases or can be used for decorative effects.

Product Characteristics

- Available in 58mm (2.9W)
- Available in 4000K and Emotion (2700K-6500K)
- Change color temperature (WW to CW) with Emotion Technology
- CRI >80
- Opaque lens offers no visible diodes
- Available in stainless steel finish; other colors available on request
- Attached 2m (7ft.) cord

Suitable Applications

- Retail Displays
- Casework
- Cabinet Interiors
- Shelving
- Under Cabinet

Specifications

	4000K	Emotion
DIA (Hole)	58mm (2.3")	58mm (2.3")
DIA (Puck)	70mm (2.8")	70mm (2.8")
W	2.9W/Spot	2.9W/Spot
Lm	140lm/Spot	225lm/Spot
Max 18W Driver	6	6
Max 36W Driver	12	12
Max 48W Driver	16	16
Max 60W Driver	20	20

Photometrics

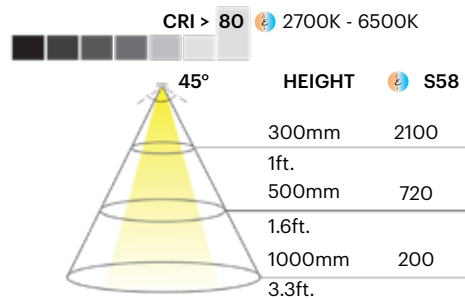

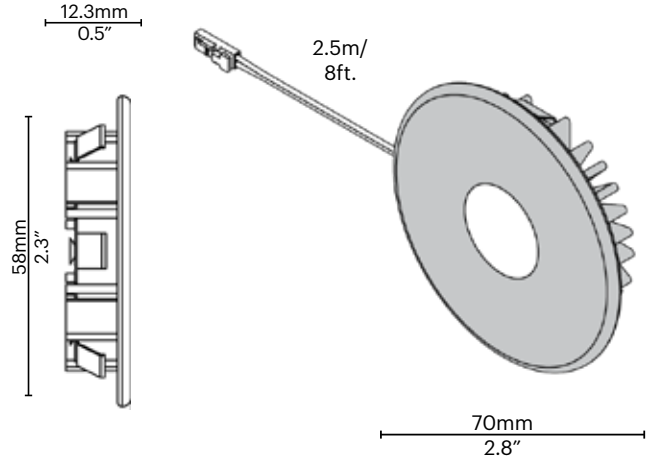

Superlight

12V / 58mm / 4000K

Item Code	DIA (hole)	DIA (puck)	Wattage	Lumen	Kelvin	Finish
1200056	58mm/2.3"	70mm/2.8"	2.9W/Spot	140lm/Spot	4000K	Stainless Steel

Superlight

12V / 58mm / Emotion

Item Code	DIA (hole)	DIA (puck)	Wattage	Lumen	Kelvin	Finish
1200053	58mm/2.3"	70mm/2.8"	2.9W/Spot	225lm/Spot	2700K-6500K	Stainless Steel

Additional Accessories

Item Code	Accessories	L (mm/ft)
1540601	Extension Cords for light fixture (Fixture to Driver & Fixture to Fixture)	250mm / 1ft.
1540701		500mm / 2ft.
1540801		1000mm / 3ft.
1540901		2000mm / 7ft.

Power Supplies

12V

Product Details	Wattage
MEC Driver w. Distributor Module More informaton about power supplies on page 118.	12V 18W, 36W, 48W, 60W 

SUPERSPOT



The Superspot is a recessed, adjustable spotlight perfect for display cases. It features a 180° range of motion with an optical lens designed for enhanced light diffusion.

Product Characteristics

- Available in 48mm and 62mm (Puck)
- 58mm Ring for expanded diameter
- Available in 5000K and Emotion (2700K-6500K)
- Change color temperature (WW to CW) with Emotion Technology
- CRI >80
- Available in gray finish; other colors available on request
- Attached 2m (7ft.) cord

Suitable Applications

- Retail Displays
- Cabinet Interiors
- Under Cabinet
- Casework
- Shelving

Specifications

	Emotion	5000K
DIA (Hole)	42mm (1.7")	42mm (1.7")
DIA (Puck)	48mm (1.9")	48mm (1.9")
W	2W/Spot	2W/Spot
Lm	80lm/Spot	150lm/Spot
Max 18W Driver	9	9
Max 36W Driver	13	13
Max 48W Driver	24	24
Max 60W Driver	30	30

Photometrics

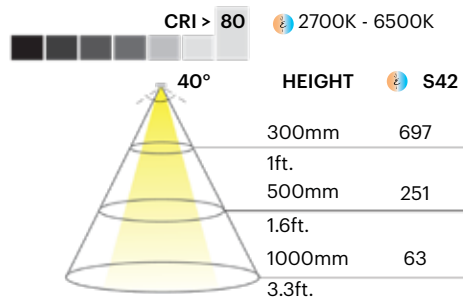

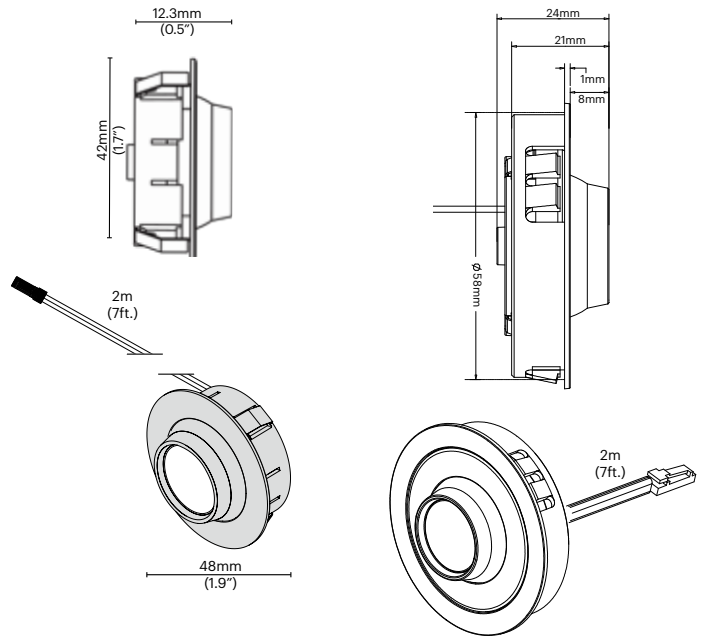
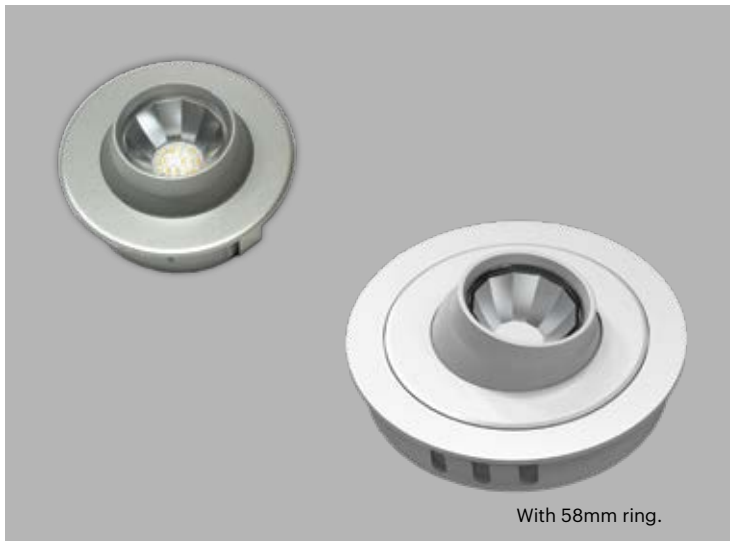

Superspot

12V / 42mm

Item Code	DIA (hole)	DIA (puck)	Wattage	Lumen	Kelvin	Finish
1232604	42mm/1.7"	48mm/1.9"	2W/Spot	80lm/Spot	2700K-6500K	Gray
1200072				150lm/Spot	5000K	

Additional Accessories

Item Code	Accessories	L (mm/ft)
1540601	Extension Cords for light fixture (Fixture to Driver & Fixture to Fixture)	250mm / 1ft.
1540701		500mm / 2ft.
1540801		1000mm / 3ft.
1540901		2000mm / 7ft.

Accessories

58mm

Item Code	Product Details	DIA (hole)	DIA (puck)	Finish
1200075	Ring to expand light to fit 58mm recessed hole.	58mm (2.3")	62mm (2.4")	Gray

Power Supplies

12V

Product Details	Wattage
MEC Driver w. Distributor Module More informaton about power supplies on page 118.	12V 18W, 36W, 48W, 60W 

TAOS



The Taos is an ultra-thin LED light panel with no visible diodes or hotspots. The 10mm (0.39") deep profile features a clear plastic lens painted from behind, giving it a sleek, modern look while also protecting the finish.

Product Characteristics

- Available recessed and surface mounted
- Low energy consumption with 5.5W
- Available in Emotion (2700K-6500K)
- Change color temperature (WW to CW) with Emotion Technology
- Available in black and nickel finish
- Mounting kit for surface mounting included
- Attached 2m (7ft.) cord

Suitable Applications

- Retail Displays
- Cabinet Interiors
- Under Cabinet
- Casework
- Shelving

Specifications

	Emotion
L	187mm x 107mm (7.4" x 4.2")
W	5.5W/Spot
Lm	1350lm/Spot
Max 18W Driver	3
Max 36W Driver	6
Max 48W Driver	8
Max 60W Driver	10

Photometrics

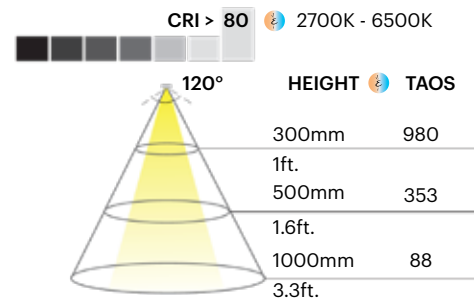

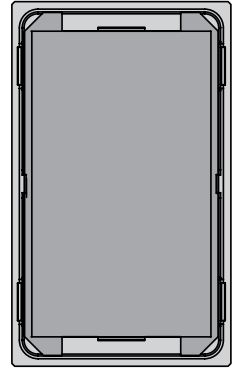
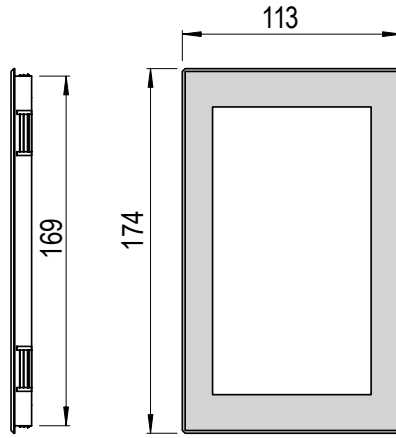
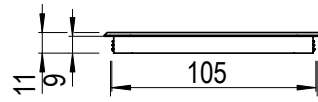

Taos

12V

Item Code	L (mm)	L (inch)	Wattage	Lumen	Kelvin	Finish
1231270*	174mm x 113mm	6.85" x 4.44"	5.5W/Spot	1350lm/Spot	2700K-6500K	Nickel
1231271						Black
1231272						

*Surface mounted.

Additional Accessories

Item Code	Accessories	L (mm/ft)
1540601	Extension Cords for light fixture (Fixture to Driver & Fixture to Fixture)	250mm / 1ft.
1540701		500mm / 2ft.
1540801		1000mm / 3ft.
1540901		2000mm / 7ft.

Power Supplies

12V

Product Details	Wattage
MEC Driver w. Distributor Module More informaton about power supplies on page 118.	12V 18W, 36W, 48W, 60W 

NEW DAHLIA



The DAHLIA is an elegant recessed ceiling light, featuring an adjustable head that can be easily positioned to illuminate any desired direction. Complete with an integrated driver, this modern fixture is available in both black and white finishes.

Product Characteristics

- Available in three sizes: 1, 2, or 3-head Version
- Standard in 3500K and 4000K, also available in 2700K and 3000K with extended lead times
- Standard in beam angle: 24°, also available in 15° and 38° with extended lead times
- CRI >90+
- Aluminum cast housing
- Integrated driver (500mA, Triac)
- High lumen output: 80lm/w
- Head can be moved vertically, tilted (90°), and rotated (360°)
- Available in black and white finish

Suitable Applications

- Retail
- Office
- Commercial
- Public Spaces

Driver Specifications

Input Voltage	120VAC
Frequency Range	50/60Hz
Dimming	Triac
Power Factor	>0.9
Output Voltage	500mA



Mounting Accessories

Item Code	Description	Dahlia Version	Dimensions
600800026	New Construction Plate with Hanger Bars. Only required for new construction projects.	Dahlia, 1-head	306.2x216.2x25mm
600800027		Dahlia, 2-head	389x216.2x25mm
600800028		Dahlia, 3-head	523x288x25mm



Picture: New Construction Plate for Dahlia, 1-head fixture.



DAHLIA

One-Head

Item Code	Dimensions	Wattage	Kelvin	Lumen	Beam Angle	Finish
504100002	159x159x-221mm (6.2x6.2x8.7")	22W (fixture)	3500K	1760lm/ light	24	White
504100003						Black

Additional color temperatures (CCT), BA, and finish available on request.

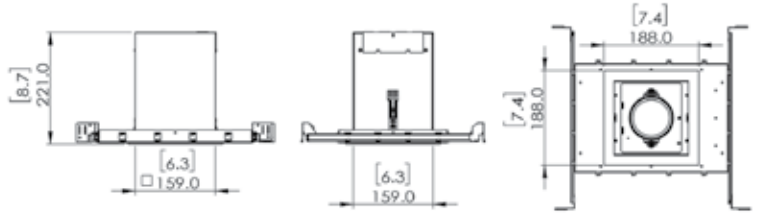

DAHLIA

Two-Head

Item Code	Dimensions	Wattage	Kelvin	Lumen	Beam Angle	Finish
504100004	159x313x-221mm (6.2x12.3x8.7")	44W (fixture)	3500K	1760lm/ light	24	White
504100005						Black

Additional color temperatures (CCT), BA, and finish available on request.

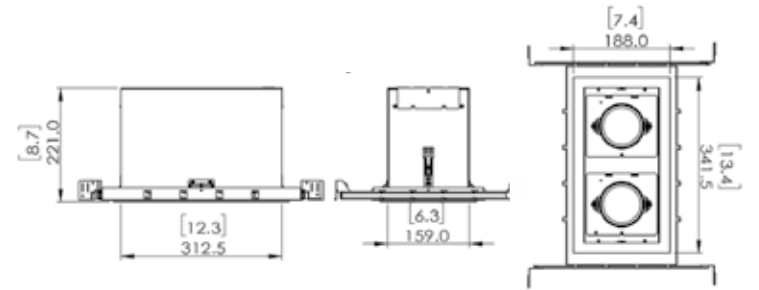

DAHLIA

Three-Head

Item Code	Dimensions	Wattage	Kelvin	Lumen	Beam Angle	Finish
504100006	159x469x-221mm (6.2x18.4x8.7")	66W (fixture)	3500K	1760lm/ light	24	White
504100007						Black

Additional color temperatures (CCT), BA, and finish available on request.

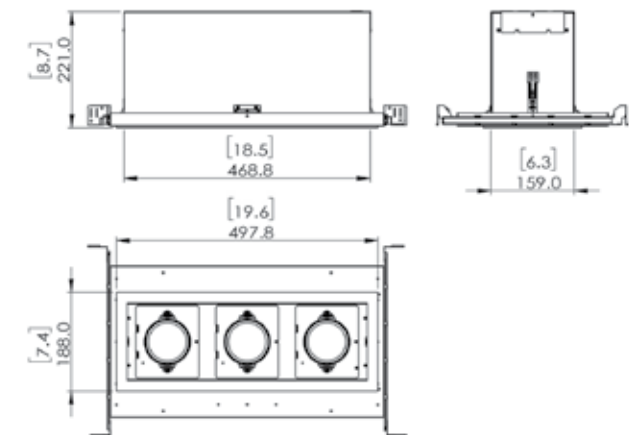

NEW SAVANNAH



Savannah is a premium ceiling track light engineered for optimal efficiency and impact in retail and commercial settings. Available in a range of color temperatures and beam angles, Savannah delivers outstanding color rendering, ensuring products and displays are showcased in their best light.

Product Characteristics

- Available in 3500K, 2700K, 3000K, and 4000K on request
- CRI >90
- Included TRIAC dimming driver (350mA)
- Standard in 25° beam angle, available in 20°, 38°, and 50° on request
- Track and accessories sold separately
- ETL certified
- Available in black and white finish

Suitable Applications

- Retail
- Hospitality
- Ceiling
- Office

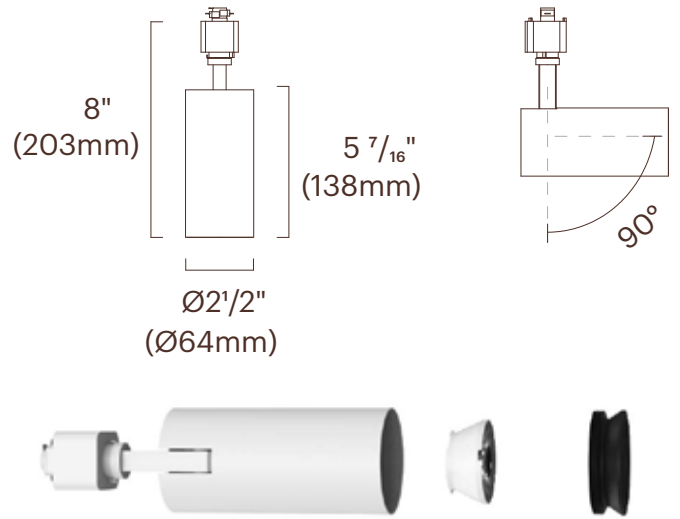

Savannah Track Light

350mA

Item Code*	BA	Wattage	Kelvin	Lumen	Finish
504800001	25°	15W	3500K	1342lm	Black
504800002					White

Additional color temperatures (CCT) and Beam Angle are available on request. Expected lead time 4 weeks + shipping.

Track System

Item Code	Length	Details	Finish
752200895	1219mm (4ft.)	Single Circuit Track Section, surface mounted, includes 2x end caps	Black
752200893			White
752200896	2438mm (8ft.)		Black
752200894			White

NOTE: Track system also available for recessed installation.

Track cross section.



Accessories

Item Code	Details	Finish
943800141	A - End Cap / Closure Head	Black
943800140		White
On request	B - Electrical Head	Black
On request		White
940700016	Linear Joint / Interconnect	Black
940700015		White
On request	C - Linear Joint / For concealed track	Black
On request		White
On request	D - L Joint	Black
On request		White
On request	E - T Joint	Black
On request		White
On request	F - X Joint	Black
On request		White
600800036	Suspension Cable Kit	Black
600800037		White

NOTE: Each connector can be ordered with a cover piece.

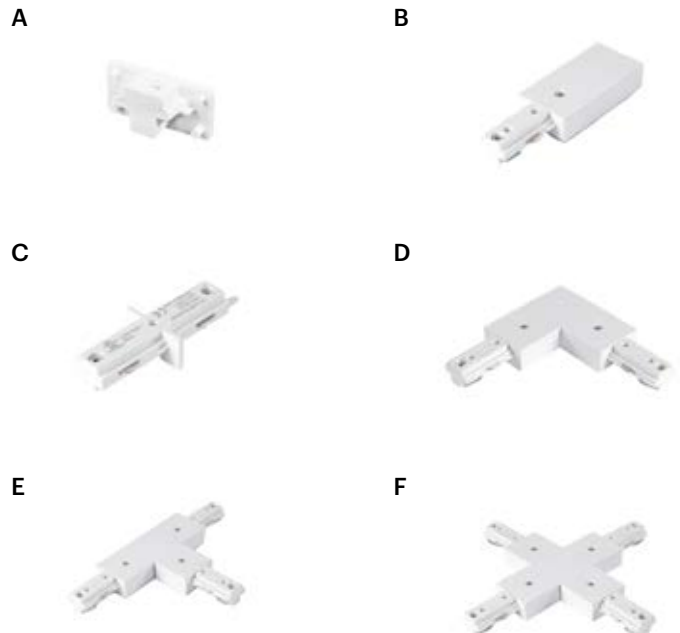

Panels



SOLARIS



85
L5



85
DOUBLE SIDE



85
L7



85
BACK

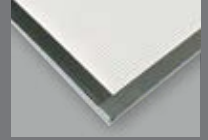

85
LUMI



85
SNAP-IN

SOLARIS
CEILING

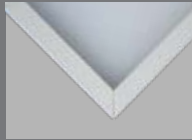

86
CEILING

































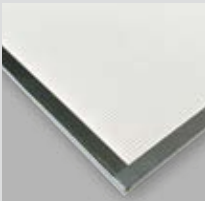

SEG
LIGHT BOX



88
NEW!
LIGHT BOX

SOLARIS APPLICATIONS & ENVIRONMENTS



Solaris		Dimensions	Input	Number of outlets	Light source
L5					
	<ul style="list-style-type: none"> Anodised aluminium frame Suitable as a backlight for furniture and walk-in wardrobes Suitable for decorative wall applications as visual communication 	Thickness: 20 mm (0.8") Max L x H: 3000 x 2000 mm (9.8ft x 6.5ft)	 	One cable outlet per illuminated side. Single cable option for 12V versions up to 36W and 24V versions up to 72W	  
DOUBLE SIDE					
	<ul style="list-style-type: none"> Anodised aluminium frame Lighting on both panels Suitable for signage and visual communication applications 	Thickness: 15 mm (0.6") Max L x H: 1500 x 1500 mm (4.9ft x 4.9ft)	 	One cable outlet per illuminated side. Single cable option for 12V versions up to 36W and 24V versions up to 72W	  
L7					
	<ul style="list-style-type: none"> Without frame Suitable as a backlight for furniture and walk-in wardrobes 	Thickness: 9,5 - 10,5 mm (0.37" - 0.41") Max L x H: 2100 x 1100 mm (6.9ft x 3.6ft)		One cable outlet.	  
BACK					
	<ul style="list-style-type: none"> Without frame Suitable as a backlight for furniture and walk-in wardrobes 	Thickness: 13 mm (0.5") Max L x H: 3000 x 2000 mm (9.8ft x 6.5ft)	 	One cable outlet per illuminated side. Single cable option for 12V versions up to 36W and 24V versions up to 72W	  
LUMI					
	<ul style="list-style-type: none"> Without frame Suitable as a backlight and light box Can be integrated with decorated front panels for the production of visuals, window dressing and communication 	Thickness: 6 mm (0.23") Max L x H: 3000 x 2000 mm (9.8ft x 6.5ft)	 		  
SNAP IN					
	<ul style="list-style-type: none"> Anodised aluminium frame that can be opened for easy insertion and replacement of prints Suitable for wall applications and as visual communication 	Thickness: 16 mm (0.62") Max L x H: 3000 x 2000 mm (9.8ft x 6.5ft)	 	One cable outlet per illuminated side. Single cable option for 12V versions up to 36W and 24V versions up to 72W	  

SOLARIS CEILING



The ultra-slim, edge-lit LED panel configuration combined with high performance LED chips and leading technology diffuser makes the Solaris Ceiling the ideal solution for any commercial lighting installation. This high efficacy luminaire provides long-life and uniform illumination, as well as standard 0-10V dimming capability.

Product Characteristics

- Available in two different sizes
- Standard in 4000K; 3500K and 5000K available on request
- Energy efficient and long lifetime panel solution (>50k hours)
- High efficiency LED chips focus light into lighting transmitter reducing eye strain from traditional lighting
- 120° beam angle provides high vertical illumination
- CRI >80
- High-performance driver features over-voltage, under voltage, short-circuit and over temperature protection
- 0-10V dimming (10%-100%) standard
- Standard universal Voltage 120Vac, Input 50/60Hz
- Operating temperature: -10°C to +40°C (+14°F to +105°F)
- Exceptionally strong & lightweight structured aluminum frame with maximum strength and durability
- Mounting pan comes equipped with integral earthquake clips

Suitable Applications

- Ceiling
- T bar ceiling systems

Specifications

	4000K	
Size	2ft. x 2ft. (610mm x 610mm)	2ft. x 4ft. (610mm x 1220mm)
W	25W	40W
Lm	3125lm	5000lm



PANEL 2x2 ft.

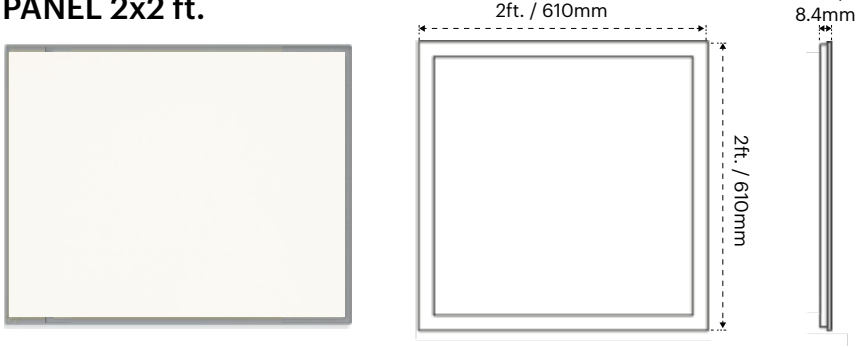

PANEL 2x4 ft.

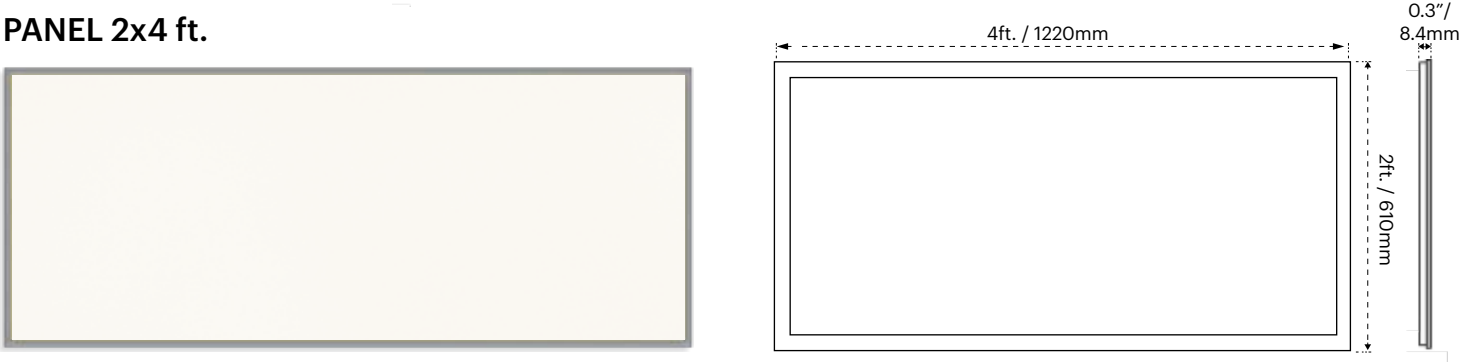

Solaris Ceiling

120Vac

Item Code	Size (mm)	Size (ft.)	Wattage	Kelvin	Lumen
3001123	610mm x 610mm	2ft. x 2ft.	25W	4000K	3125lm
3001124	610mm x 1220mm	2ft. x 4ft.	40W	4000K	5000lm

Accessories

Item Code	Accessories	Details
5300044	Suspension Kit for 2ft. x 2ft. Panel	4pcs. of each: 1.5m (5ft.) steel wire, wire lock, plastic nails, screws
5300045	Suspension Kit for 2ft. x 4ft. Panel	6pcs. of each: 1.5m (5ft.) steel wire, wire lock, plastic nails, screws

INSTALLATION

- Fixture installs by lifting it through grid ceiling and resting it on the T-bars
- Optional surface mount or suspended 4 point aircraft cable mount is available via accessory kits

NEW SEG LIGHT BOX



Meet the new L&S high performance SEG Light Box. Fully customizable in size with three different frame sizes from narrow to large. Bright and even illumination with high efficiency LEDs.



Product Characteristics

- Fully customizable length and height
- Three different frame sizes (40mm, 55mm, 64mm)
- 24V output with external low-voltage driver (MEC Driver)
- Standard cable exit on back
- Standard in 4000K; 6000K on request
- High efficiency, low consumption LEDs
- Max. capacity per driver: 60W, additional drivers can be added for higher wattage requirements.
- ETL certified (UL48)
- Indoor use only

Benefits & Key Features

- » Three frame sizes to choose from to best fit the customers needs
- » Customized size to meet the customers exact requirements
- » Simply attach and detach fabrics via silicon edge
- » Order the desired fabric, easily switch out graphics
- » Control Light Box via controller, app, sensor, or direct distributor using the MEC System

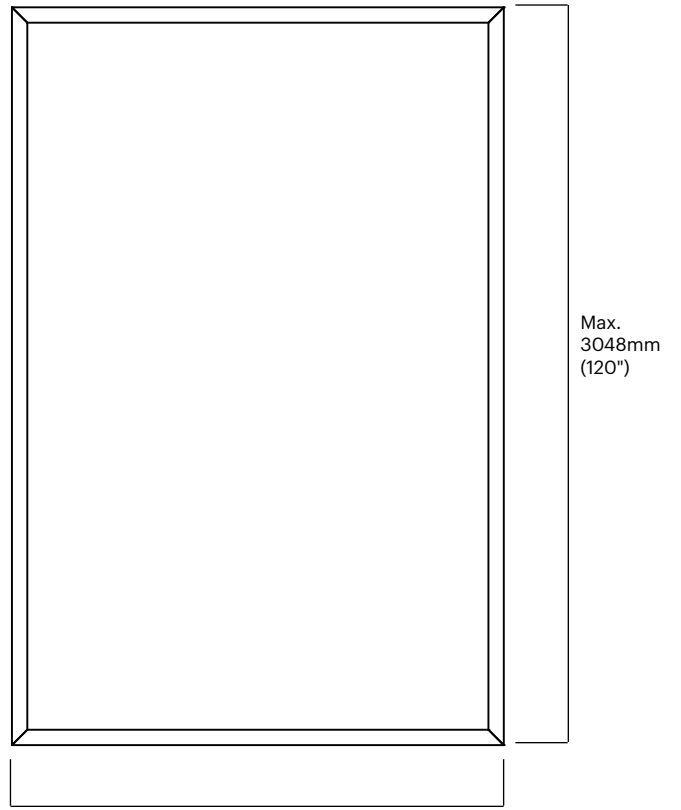

L&S SEG Light Box

24V

Item Code	CCT	Frame Depth	Dimensions
535300008	4000K	40mm (1.6")	Custom size (max. dimensions 3048x3048mm / 120x120")
535300009		55mm (2.2")	
535300010		64mm (2.6")	

LED Specifications

Lumen/W	139
CCT	4000K 6000K (on request)
Wattage/LED	0.36W
LED Barsw	2, 6, 12 LEDs/bar



Example: 2 LEDs/bar



Example: 6 LEDs/bar



Frame Specifications

Material	Aluminum
Dimensions (Frame Depth)	40mm (1.6") (<i>standard light diffusion</i>)
	55mm (2.2") (<i>enhanced light diffusion</i>)
	64mm (2.6") (<i>premium light diffusion</i>)
Max. Dimensions (L x H)	3048x3048mm (120x120")

LED Installation Guide

Frame Depth	Recommended distance between LED Bars
40mm (1.6")	80mm (3.2")
55mm (2.2")	130mm (5.1")
64mm (2.6")	150mm (5.9")

Modular Systems



ELECTRIFIED
RAILS



92
SIGN

ELECTRIFIED
MODULAR
STRUCTURES



96
NEW!
THIN LINE



100
NEW!
HI LINE



104
POWERLINE



112
MINI TRACK 2

LUXURY
SYSTEMS



114
AVIOR

SIGN

—
The functional
light that furnishes



Style and flexibility. A functional and consistent solution for almost any environment: kitchen, living space, bedroom, bathroom, office, shops.

The structural element, a matt black anodised aluminum profile, can be complemented with a range of accessories and hanging cabinets to help furnish your home or commercial space.

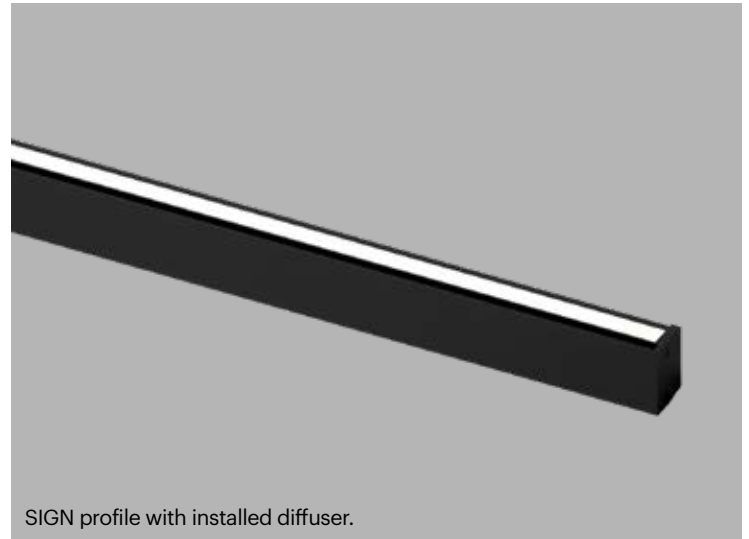
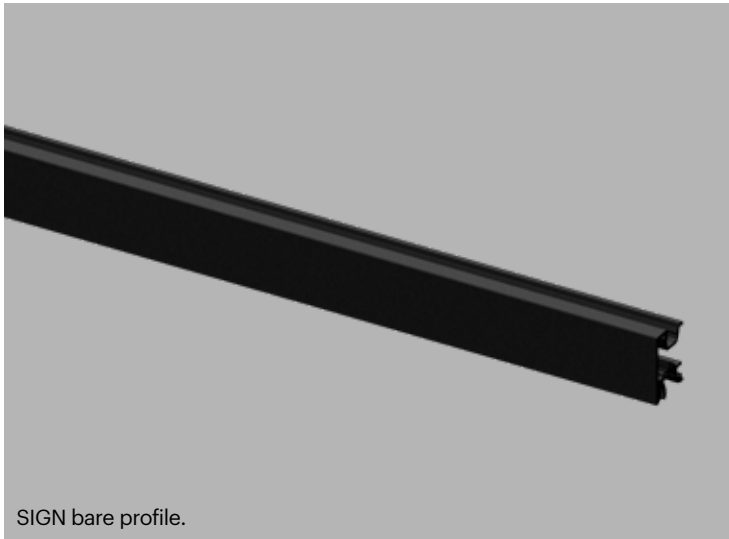

Profile and end caps

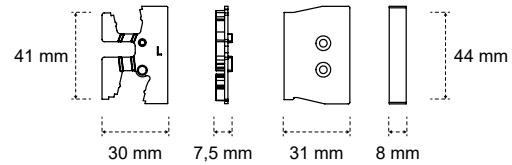

Opaque Lens for upward light

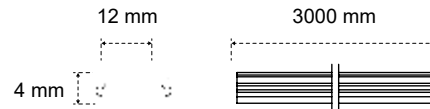

Product Characteristics

- The horizontal profile is designed with an upward wall wash effect and a downward light to illuminate the area below evenly
- Modular system with a large selection of components & accessories for residential or commercial use
- A functional and consistent design for various environments
- IP44 protection rating, safe to use in moist environments
- Profile can house cables to help organize and keep a clean look
- Wall mounting via fixing clips and anchoring profile
- Black matt finish

SIGN is fully customizable!

SIGN		Profile & Accessories		
Item Code*	Description	L (mm)	L (ft)	Finish
3871000	A - Wall mounting profile	3000mm	10ft.	Black
3832001	B - Opaque Lens	3000mm	10ft.	
3830001	C - Fixing Clips			Black
3830003	D - Anchoring Profile			Aluminum
3830006	E - End Caps (set of two)			Black
3830007	F - Screws and anchor			

*For custom length add -99 to item code.

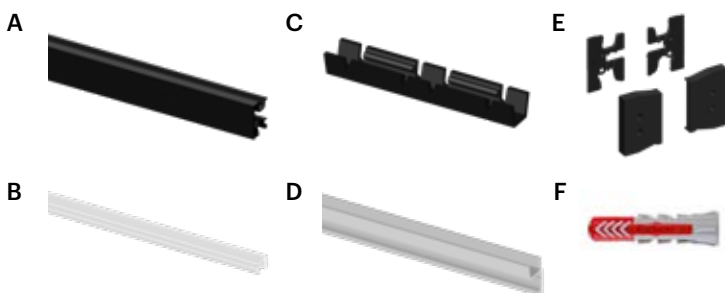

LED Options				24V	
Item Code	L (m)	L (ft)	Wattage	Kelvin	Lumen
941900053	5m	16ft.	13W/m (4W/ft.)	2700K	1950lm/m (594lm/ft.)
941900041				3000K	
941900043				4000K	
941900045				5000K	
941900014				6000K	
1124135	10m	32ft.		3000K-5000K	1170lm/m (357lm/ft.)
1124126				2700K-6500K	

Additional LED Strips on page 48.

SIGN COMPONENTS

Horizontal Modules

Module		1 Compartment
Dimensions (mm)	Dimensions (in)	Finish
300x400x150mm	12x16x6"	Black
450x400x150mm	18x16x6"	
600x400x150mm	24x16x6"	

Module		2 Compartments
Dimensions (mm)	Dimensions (in)	Finish
900x400x150mm	35x16x6"	Black

Module		3 Compartments
Dimensions (mm)	Dimensions (in)	Finish
1200x400x150mm	47x16x6"	Black

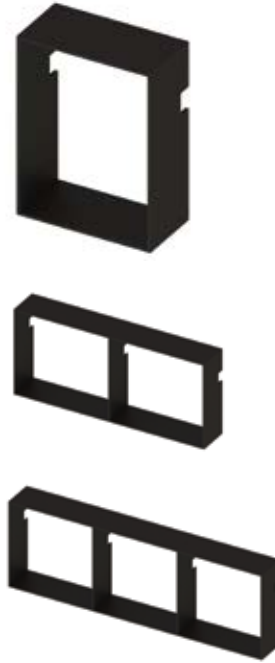

Vertical Modules

Module		3 Compartments
Dimensions (mm)	Dimensions (in)	Finish
300x760x150mm	12x30x6"	Black
450x760x150mm	18x30x6"	
600x760x150mm	24x30x6"	
900x760x150mm	35x30x6"	

Module		3 Compartments
Dimensions (mm)	Dimensions (in)	Finish
300x880x150mm	12x35x6"	Black
450x880x150mm	18x35x6"	
600x880x150mm	24x35x6"	
900x880x150mm	35x35x6"	

Module		4 Compartments
Dimensions (mm)	Dimensions (in)	Finish
300x1300x150mm	12x51x6"	Black
450x1300x150mm	18x51x6"	
600x1300x150mm	24x51x6"	
900x1300x150mm	35x51x6"	



Door Modules

Door Modules

Model	Dimensions (mm)	Dimensions (in)	Finish
A	900x400x150mm	35x16x6"	Black
B	450x760x150mm	18x30x6"	
C	300x1300x150mm	12x51x6"	
D	300x1300x150mm	12x51x6"	

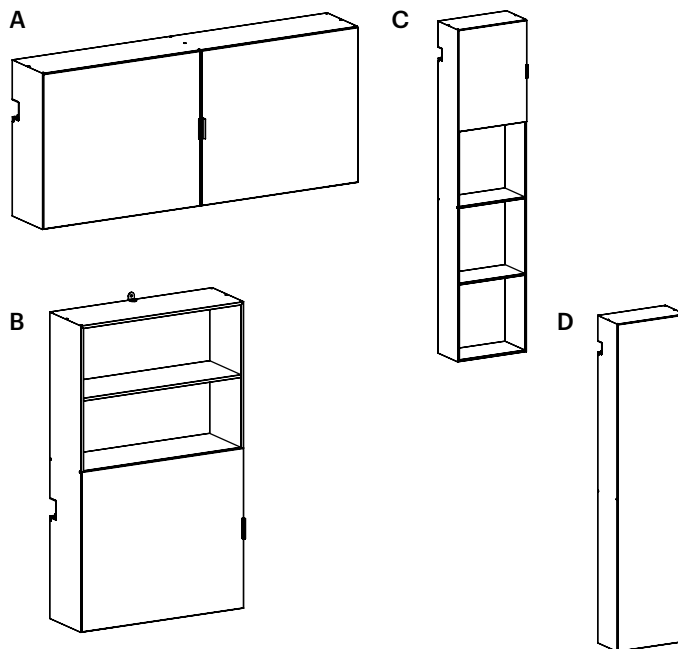

Open modules made of black scratch-resistant brushed aluminium, which can be clicked onto the Sign profile and provided with glass doors.



Doors with wood material on request.



Sign

Modules with wooden door

Additional accessories for bath & kitchen available.
Scan code to see full list of components.



NEW

THIN LINE



Modular electrified system, designed to elevate the ambiance of any space. With a wide range of configurations boasting refined aesthetics, this versatile system is perfect for both retail and home environments.

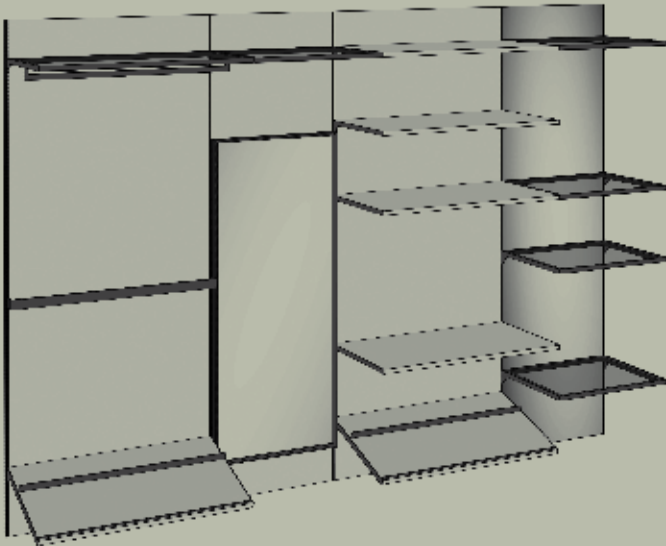

At the core of the Thin Line system lies a groundbreaking electrified concept (patent pending) to effortlessly move and position illuminated shelving units practical and secure, without visible connections or cables.

The system is very versatile and can be integrated in commercial, office, and residential environments. The minimal space between panels produces a clean and continuous surface.



IDEAL FOR

- retail, i.e. fashion, eyewear, cosmetics, pharmacy
- luxury retail
- residential, i.e. closets, living, bedroom

FEATURES

- modularity
- versatility
- no need for connectors
- no visible wiring

Contact our sales team at 770 800 1238 to learn more about Thin Line!

Find detailed information and instructions.



Tracks

Side Track

Item Code	Polarity	L (mm)	L (in)	Finish
910000065	Positive	3000mm	10ft.	Black
910000066	Negative			
910000067	Positive			Gray
910000068	Negative			



Anodized aluminum side track with a cabled slotted rack and insulated profile. Includes extension cable and foot. Screws and anchors not included. Custom sizes and finishes available upon request.

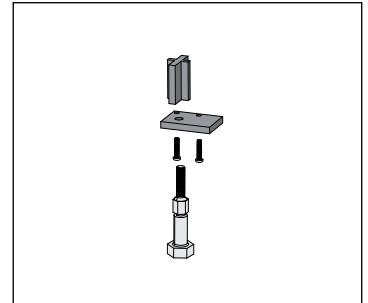
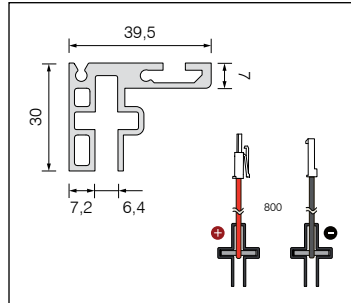

Central Track

Item Code	Polarity	L (mm)	L (in)	Finish
910000061	Positive	3000mm	10ft.	Black
910000062	Negative			
910000063	Positive			Gray
910000064	Negative			



Anodized aluminum central track with a cabled slotted rack and insulated profile. Includes extension cable and foot. Screws and anchors not included. Custom sizes and finishes available upon request.

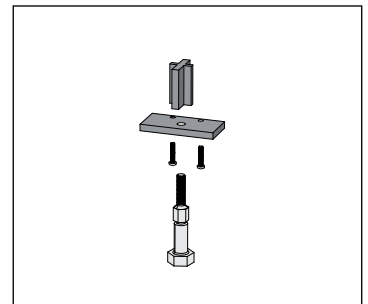
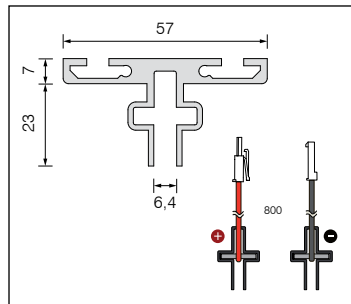

Track Accessories

Item Code	Description	Finish
600800031	A - Wall fixing brackets side	Silver
600800032	A - Wall fixing brackets central	
600800033	B - Back panel fixing screw with 4mm spacer for 18-19mm panel	Silver
600800034	B - Back panel fixing screw with 7mm spacer for 16mm panel	
600800035	B - Back panel fixing screw with 13mm spacer for 10mm panel	
On request	C - Extension cable	Red/Black
940600532	D - 6-way distribution box	White
910300010	E - Bridge cable	
940600533	F - Mec Driver connection cable	



Shelves

Shelf Brackets (standard)

Item Code	Side	L (mm)	L (inch)	Finish
942100002	Right	300mm	12"	Black
942100004	Left			
942100006	Central			
942100008	Right	500mm	20"	
942100010	Left			
942100012	Central			

The standard bracket, made of 3mm steel, comes with side (left/right) or central options for a continuous shelf flow. For optimal electrical conduction, the bracket undergoes a copper and nickel plating, followed by an insulating epoxy paint layer. Unpainted electrification contacts efficiently transfer the 24V signal from the electrified rack to the shelf lamp.

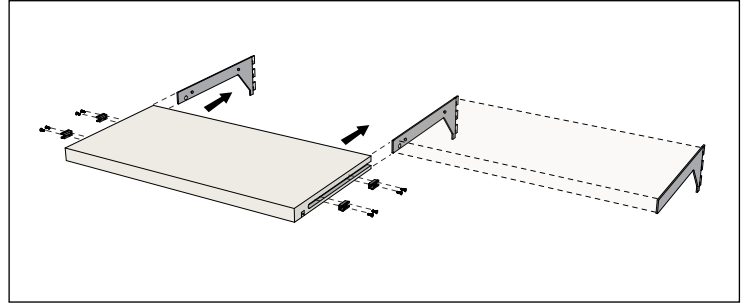
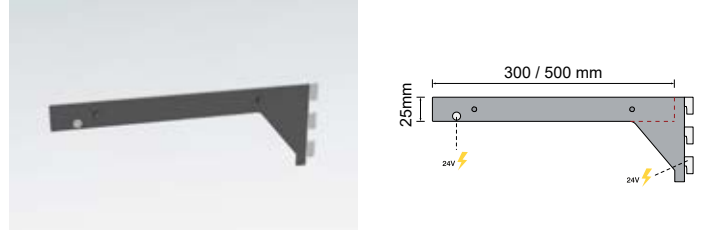

Shelf Brackets (inclined)

Item Code	Side	L (mm)	L (in)	Finish
942100014	Right	300mm	12"	Black
942100016	Left			
942100018	Central			
942100020	Right	500mm	20"	
942100022	Left			
942100024	Central			

The 20° inclined bracket, made of 3mm steel, comes with side (left/right) or central options for a continuous shelf flow. For optimal electrical conduction, the bracket undergoes a copper and nickel plating, followed by an insulating epoxy paint layer. Unpainted electrification contacts efficiently transfer the 24V signal from the electrified rack to the shelf lamp.

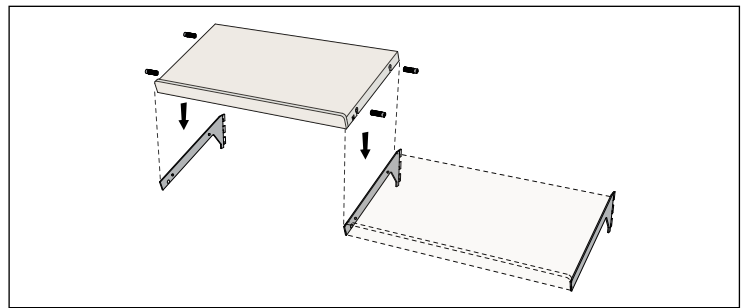
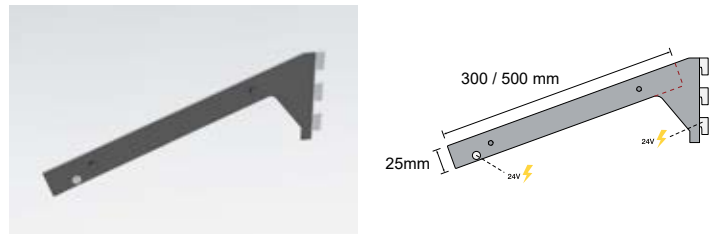

Track Accessories

Item Code	Description	Length	Wattage	CCT
520100002	A - Sky Pin linear light for Thin Line shelf	600mm (24")	4.16W	2700K
520100001				4000K
520100004		900mm (35")	6.56W	2700K
520100003				4000K
Included	B - Anti-release shelf lock (straight shelf)			
Included	C - Anti-release shelf lock (inclined shelf)			

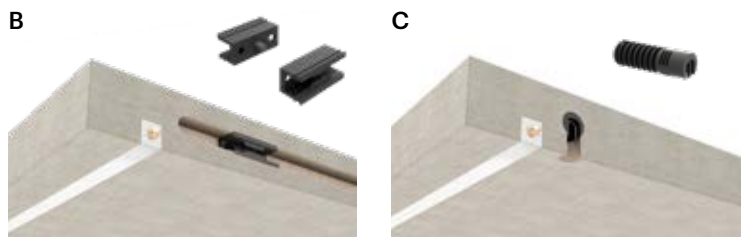

NEW

HI LINE



Horizontal illuminated free-standing modular system with integrated light. This versatile solution is perfect for all types of walls, making it an ideal choice for both retail and residential furnishing.

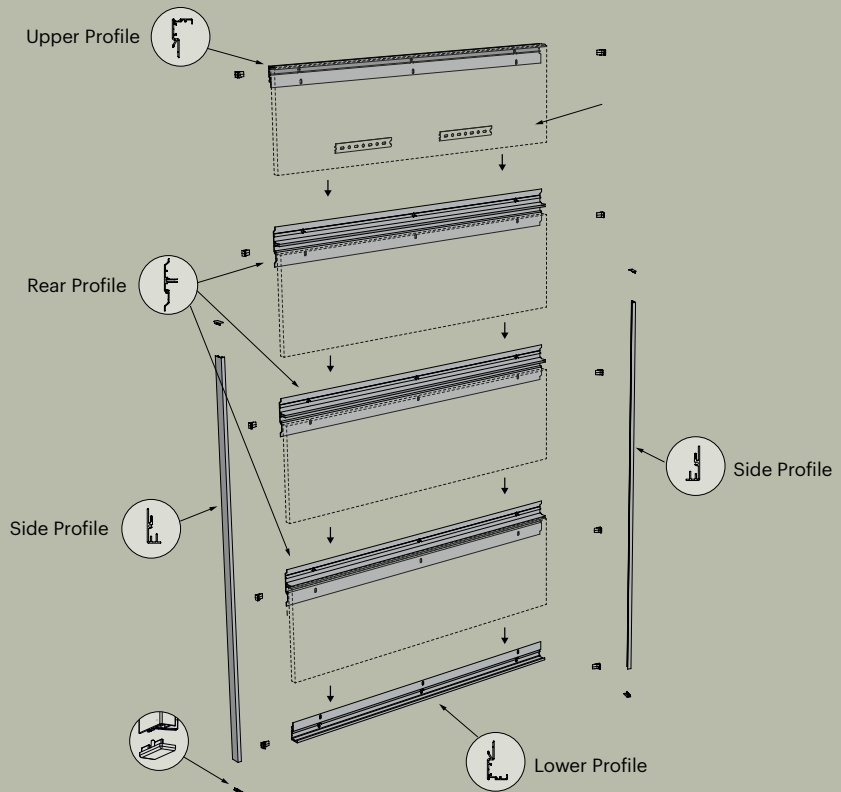

Hi Line offers versatile furnishing solutions that can be suspended or surface mounted. With a perfect blend of aluminum profiles that seamlessly integrate light sources and the use of Solaris panels, Hi Line brings a touch of elegance and functionality to any space.

- > **Compatible with the Sign System.**
- > **Beautiful lighting effects with Solaris panels.**



IDEAL FOR

- residential
- retail
- hospitality

FEATURES

- modularity
- versatility
- various solutions with different types of shelves and modules



Contact our sales team at 770 800 1238 to learn more about Hi Line!

Profile

Illuminated Profile

Item Code	L (mm)	L (in)	Wattage	CCT	Finish
On request	900mm	35"	8.1W	2700K-4000K	Black
On request	1200mm	47"	10.8W		
On request	1500mm	59"	13.8W		
On request	1800mm	71"	16.7W		

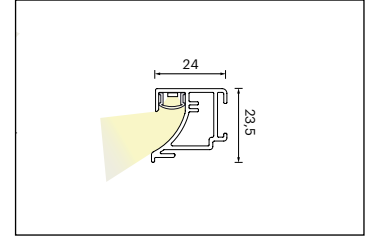

Structural Profiles

Item Code	Description	L (mm)	L (ft.)	Finish
On request	Upper/Lower Profile	3950mm	13ft.	Black
On request	Side Profile			
On request	Rear Profile			

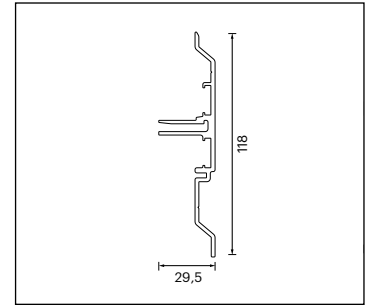
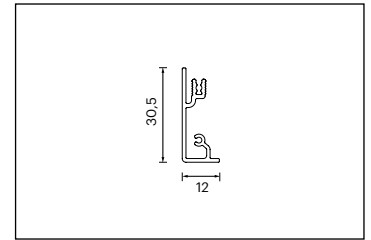
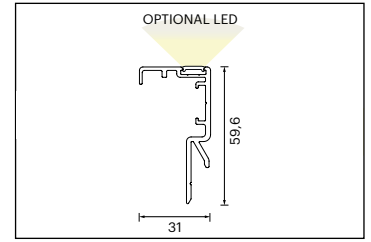
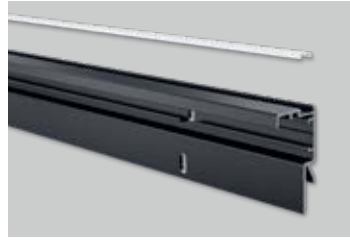

Lighting Options



Wall-washer

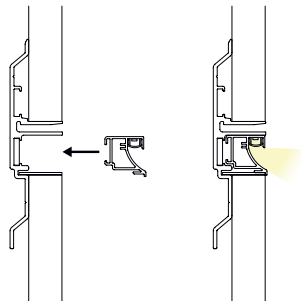

Illuminated Profile Light

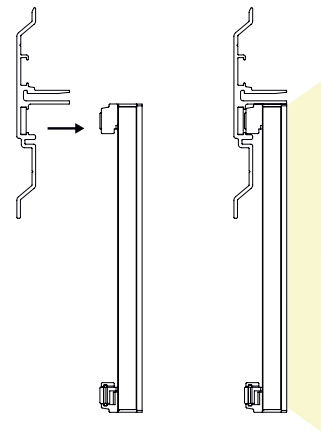

Solaris Panel Light

Shelf Modules, Shelves & Accessories

Vertical Shelf Modules

Item Code	Dimensions (mm)	Dimensions (in)	Finish
On request	A - 450x150x800mm	17.7x5.9x31.5"	Black
On request	B - 450x150x1200mm	17.7x5.9x47.2"	

Crafted from black, scratch-resistant brushed aluminum, these vertical open shelving modules can be easily integrated into the rear profile of Hi Line. Optional single glass doors are available upon request.

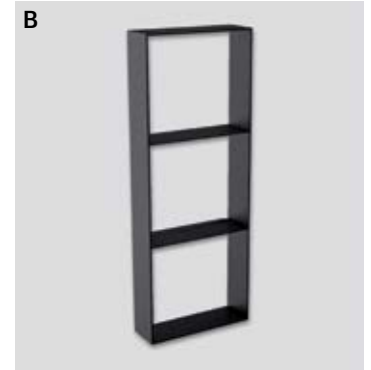
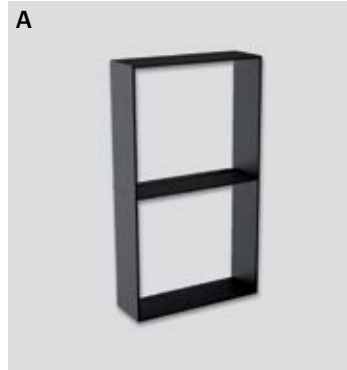

Horizontal Shelf Module

Item Code	Dimensions (mm)	Dimensions (in)	Finish
On request	900x150x450mm	35.4x5.9x17.7"	Black

Crafted from black, scratch-resistant brushed aluminum, these horizontal open shelving modules can be easily integrated into the rear profile of Hi Line.



Shelf Units

Item Code	Dimensions (mm)	Dimensions (in)	Finish
On request	265x150mm	10.4x5.9"	Black
On request	565x150mm	22.2x5.9"	
On request	865x150mm	34x5.9"	



Accessories

Item Code	Description	Dimensions	Finish
On request	Wine Glass Holder	715x150mm (28.1x5.9")	Black
On request	IPad Holder	330x118x20mm (13x4.6x0.8")	
On request	Set of 4 Hooks		



POWERLINE



NOTE: Powerline System does not include shelving material, i.e. wood or glass.

The electrified tracks enable the user to configure the wall system without restrictions. Shelves can be moved to any desired position to ensure perfectly even and comfortable lighting. With the plug&play components it is easy to integrate lighting into shelving.

Equipped with a wide range of accessories and various types of shelves and brackets, Powerline is an elegant and practical solution for retail stores and home walk-in closets.



FULL VERSATILITY

Brackets for single or continuous shelves, made for wood or glass, straight, inclined or with support for hanging bar.

MODULARITY

A modular and compatible structure that can be integrated anywhere.

PLUG & PLAY

Brackets equipped with connectors for quick installation.

PRACTICALITY

The illuminated shelves can be moved freely without the need for electrical intervention.

TAILOR-MADE

Dimensions and finishes can be customized.

VISUAL HARMONY

Designed for commercial and residential environments.

Single Track

Powerline Track

Single Track (10mm Panels)

Item Code	L (mm)	L (in)	Finish
2301001	2500mm	8ft.	Black
2301002	3000mm	10ft.	
2302001	2500mm	8ft.	Gray
2302002	3000mm	10ft.	

Single electrified track for back panels up to 10mm (0.4") thick, compatible with all types of brackets. Available in a black or gray finish.



10mm Panel Track

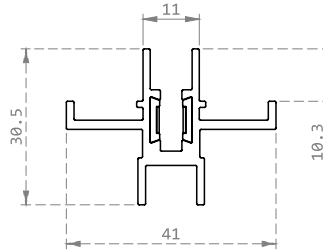

18mm Panel Track

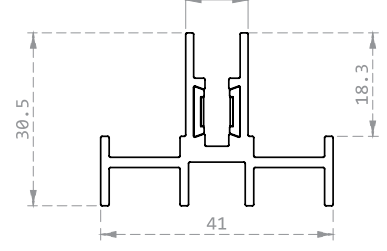

Powerline Track

Single Track (18mm Panels)

Item Code	L (mm)	L (in)	Finish
2301002-01	3000mm	10ft.	Black
2302002-01			Gray

Single electrified track for back panels up to 18mm (0.7") thick, compatible with all types of brackets. Available in a black or gray finish.

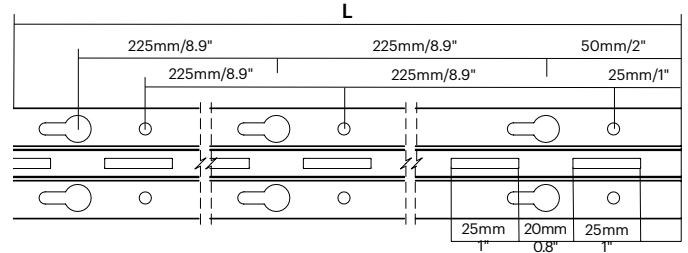

Power Connector Cap (Connects driver to track)

Single Track

Item Code	Cable Length (mm)	Cable Length (ft.)	Details / Finish
1500041	1000mm	3ft.	Top Mount / Black
1500028			Bottom Mount / Black
1500042			Top Mount / Gray
1500035			Bottom Mount / Gray

The connector cap is placed at the top or bottom of the electrified track. It is equipped with a 3ft. cable to connect to the MEC Driver (13ft. cable connection on request). Available in a black or gray finish.

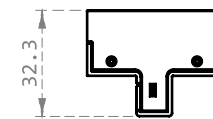
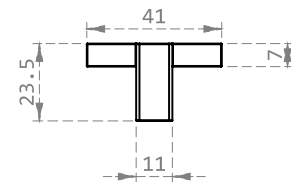

End Cap (Single Track)

Item Code	Details / Finish
1500045	Black
1500046	Gray

The end cap is placed at the top or bottom of the electrified track. It is used for the section where no power is needed. Available in a black or gray finish.

Double Track

Powerline Track

Double Track (10mm Panels)

Item Code	L (mm)	L (in)	Finish
2301003	2500mm	8ft.	Black
2301004	3000mm	10ft.	
2302003	2500mm	8ft.	Gray
2302004	3000mm	10ft.	

Tracks are also available for 18mm thick panels. Contact us for more information.

Electrified double rail for back panels up to 10mm (0.4") thick, specifically for installations where several shelves need to be placed side by side, without having to use the "line" brackets. Available in a black or gray finish.

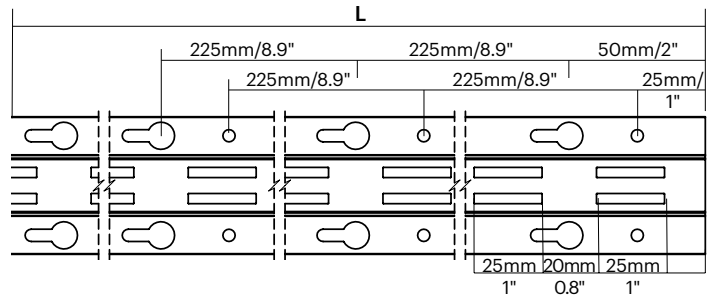
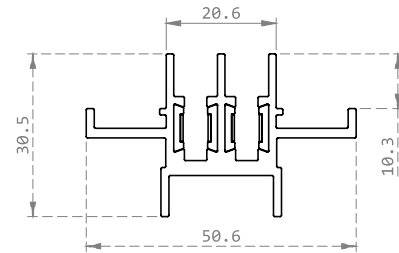

Power Connector Cap (Connects driver to track)

Double Track

Item Code	Cable Length (mm)	Cable Length (in)	Details / Finish
1500026	1000mm	3ft.	Top Mount / Black
1500029			Bottom Mount / Black
1500027			Top Mount / Gray
1500036			Bottom Mount / Gray

The connector cap is placed at the top or bottom of the electrified track. It is equipped with a cable to connect to the MEC Driver (13ft. cable connection on request). Available in a black or gray finish.

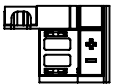
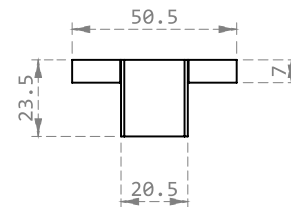

End Cap (Double Track)

Item Code	Details / Finish
1500047	Black
1500048	Gray

The end cap is placed at the top or bottom of the electrified track. It is used for the section where no power is needed. Available in a black or gray finish.

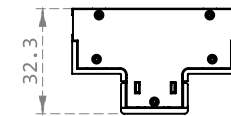

Brackets for Single Wooden Shelves

Brackets (pair for one shelf)

w. Power Connector Slot

Item Code	Details	Material	Finish
2301008	Kit (2pcs.)	Wood	Black
2302008			Gray

Kit includes a left and right bracket. The left version has a slot to insert the power connector (sold separately). Use this bracket to guide the cable underneath the shelf. Available in black or gray finish.

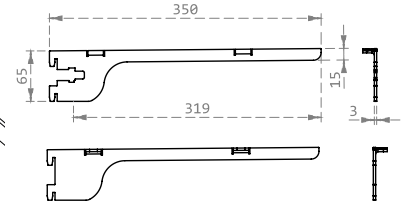
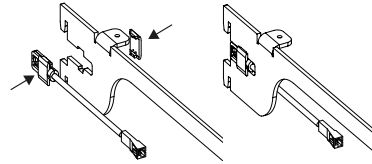

Brackets (pair for one shelf)

for Concealed Connection

Item Code	Details	Material	Finish
2301005	Kit (2pcs.)	Wood	Black
2302005			Gray

Kit includes a left and right bracket. Use the power connector holder (sold separately) to electrify the shelf through a concealed connection. Available in black or gray finish.

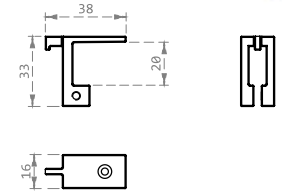
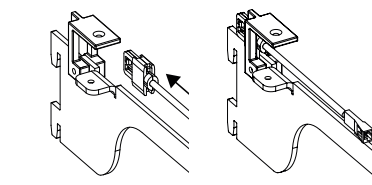

Holder for Power Connector

for Concealed Connection

Item Code	Details	Material	Finish
2301007	Kit (2pcs.)	Wood	Black
2302007			Gray

Support holder is used to retract the power connector (sold separately) for a concealed light connection. Compatible with all common shelf sizes, above 18mm (0.7") depth for wooden shelves and from 3mm to 12mm depth for glass shelves. If used with glass shelves, works also as shelf lock clip. Available in black or gray finish.

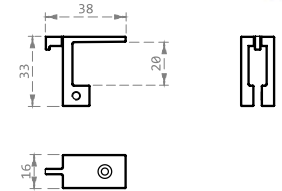
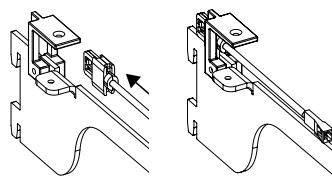

Bracket Power Connector

For light connection

Item Code	Details	Material	Finish
1500043	75mm	0.2ft.	Black
1500044	430mm	1ft.	
1500031	75mm	0.2ft.	Gray
1500030	430mm	1ft.	

Power supply connector for L&S lights, suitable for shelves in bracket or concealed bracket versions.

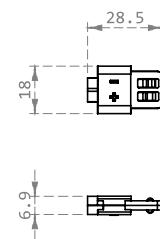

Brackets for Multiple Wooden Shelves "Line" Series

Brackets (Multiple Shelves)

Side Brackets

Item Code	Details	Version	Finish
5231001	Kit (2pcs.)	Electrified	Black
5231011		Without light	
5232001		Electrified	Gray
5232011		Without light	

Pair of left and right brackets, designed to flank and align several shelves. In the electrified version, the left bracket has a slot for the power connector for L&S lights (sold separately).

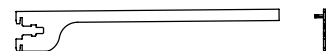
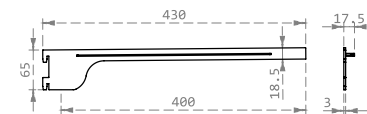

Brackets (Multiple Shelves)

Central Brackets

Item Code	Details	Version	Finish
5231002	Single (1pc.)	Electrified	Black
5231012		Without light	
5232002		Electrified	Gray
5232012*		Without light	

Central bracket designed to allow several shelves to be placed side by side and aligned. The electrified version has a slot for the power connector.

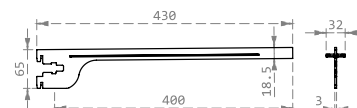

Brackets (Multiple Shelves)

Inclined / Side Brackets

Item Code	Details	Version	Finish
5231003	Kit (2pcs.)	Electrified	Black
5231013		Without light	
5232003		Electrified	Gray
5232013		Without light	

Pair of left and right angled brackets, designed to allow several shelves to be placed side by side and aligned. In the electrified version, the left bracket has a slot for the power connector.

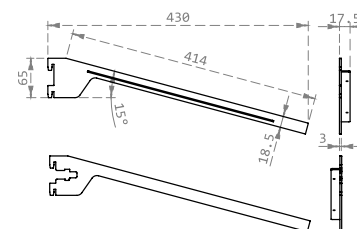

Brackets (Multiple Shelves)

Inclined / Central Brackets

Item Code	Details	Version	Finish
5231004	Single (1pc.)	Electrified	Black
5231014		Without light	
5232004		Electrified	Gray
5232014*		Without light	

Central inclined bracket designed to be able to place and align several shelves side by side. The electrified version has a slot for the power connector.

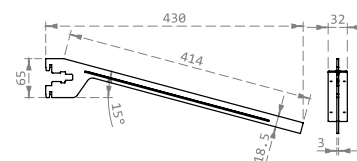
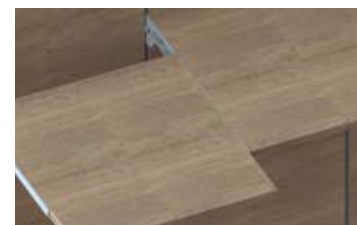

*Extended lead times expected for this part. Please contact your sales representative for details.

Brackets for Glass Shelves

Brackets

For Glass Shelves

Item Code	Details	Material	Finish
2301006	Kit (4pcs.)*	Glass	Black
2302006			Gray

*Includes support holder to hold glass shelf in place.

Pair of left and right brackets with support holder (2pc. kit). On the left-hand version, space is provided for quick and easy installation of the power connector for L&S lights (sold separately).

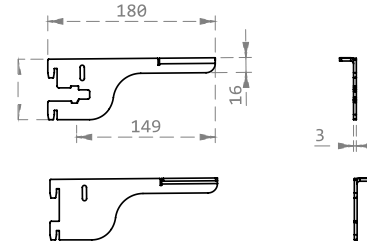

Support Holder

For Glass Shelves

Item Code	Details	Material	Finish
2301007	Kit (2pcs.)	Glass	Black
2302007			Gray

Bracket support with concealed connector, suitable for glass shelves from 3mm to 12mm (0.12" to 0.47") . The support holder is used with the bracket to hold the glass shelf in place.

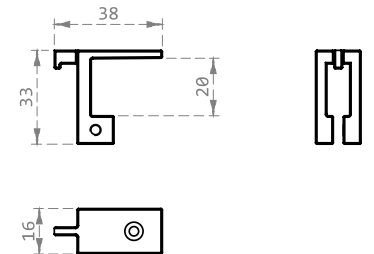

Brackets for MEC Rack

Brackets for MEC Rack

For Concealed Connector

Item Code	Details	Material	Finish
5230010	Kit (2pcs.)	Wood	Black
5230020			Gray

Pair of left and right brackets specially designed to accommodate the MEC Rack hanger tube. On the left-hand version, space is provided for quick and easy installation of the power connector for L&S lights (sold separately).

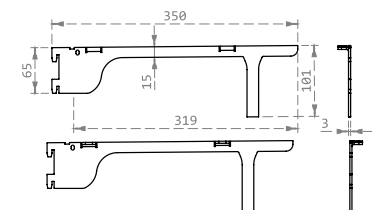

Find more information about MEC Rack on page 63!

Powerline: easy to install, quick to move, perfect to illuminate.

ELECTRIFIED VERSATILE
STRUCTURE, SUITABLE FOR
RESIDENTIAL AND RETAIL ENVIRONMENTS

MINI TRACK 2



The Mini Track 2 system offers flexible positioning for lighting applications, making it ideal for adjustable shelves. The updated second version is smaller than the first generation. It comes in various lengths and finishes and is compatible with most L&S Linear lights.

Product Characteristics

- Works with 12V & 24V Systems
- Can be combined with most L&S Linear lights
- Tracks are available in three standard lengths
- Available in white and black finish
- Cords feature integrated magnets for easy attachment under the shelf

Suitable Applications

- Retail Display
- Shelving



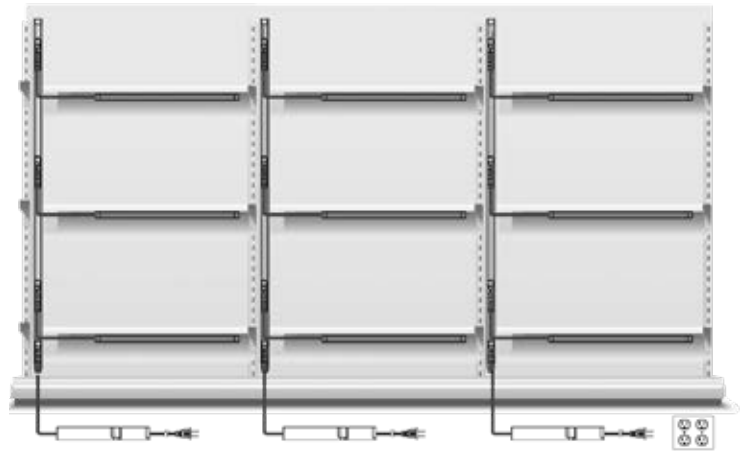
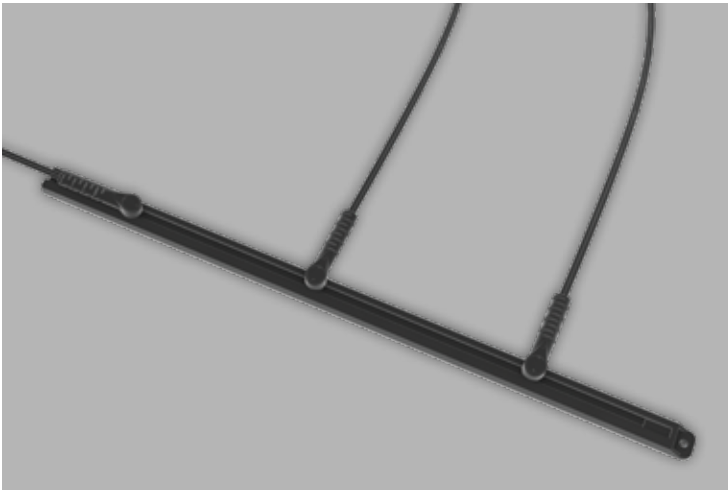

Mini Track 2

12V / 24V

Item Code	L (mm)	L (in)	Finish
2396041	1200mm	47"	White
2396051	1800mm	71"	
2396061	2500mm	98"	
2396042	1200mm	47"	Black
2396052	1800mm	71"	
2396062	2500mm	98"	

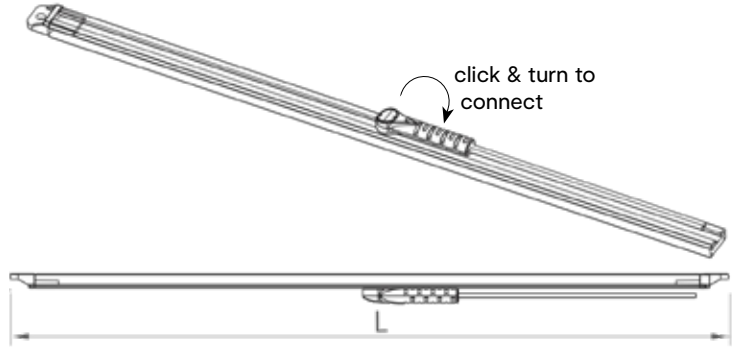

Fixture Plug

(Light to track connector w. magnets)

12V / 24V

Item Code	L (mm)	L (in)	Finish
1533511	75mm	3"	White
1533411	430mm	17"	
1533512	75mm	3"	Black
1533412	430mm	17"	

Fixture Plug (Light to track connector)

Power Track

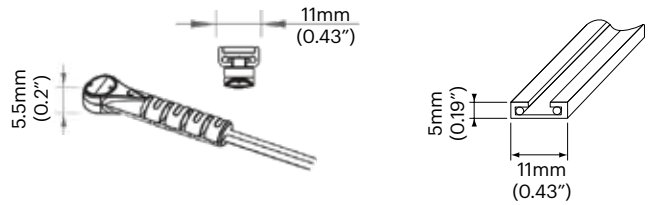

Power Plug

(Driver to track connector)

12V / 24V

Item Code	L (mm)	L (in)	Wattage	Details	Finish
1500020	1000mm	39"	max. 90W	For standard driver	White
1500021					Black
1500022				For MEC Driver	White
1500023					Black

Power Plug (Driver to track connector)

Standard Driver connection

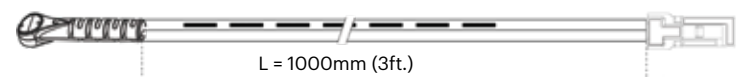

MEC Driver connection

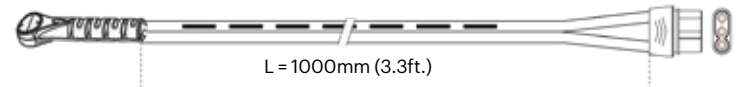

Power Supplies

12V / 24V

Product Details	Wattage
MEC Driver w. Distributor Module More information about the power supplies on page 118.	12V 18W, 36W, 48W, 60W 
	24V 18W, 36W, 48W, 72W, 90W 

NOTE: 12V LED lamps are only compatible with drivers up to 60W max.

AVIOR



Avior is the ultimate mini track system designed to enhance luxury displays, glass showcases, and museums. Create the perfect lighting atmosphere for your product by selecting the ideal lighting module – whether it be spot or linear. Avior is compatible for recessed and surface mounted installations.

Product Characteristics

- Slim track design with easy to slide-in lighting options
- Avior A, A Plus is available with beam angle 15°, 24°, 36°, or 42°
- CRI 95
- Excellent passive heat dispatching design
- Adhesive tape for mounting included
- Spring clips for recessed mounting included
- Surface mounting clips optional

Suitable Applications

- Showcase displays
- Luxury retail
- Museum

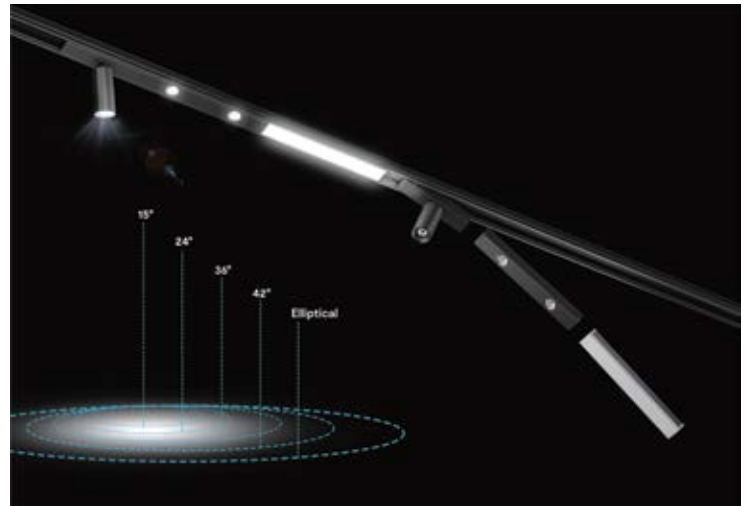

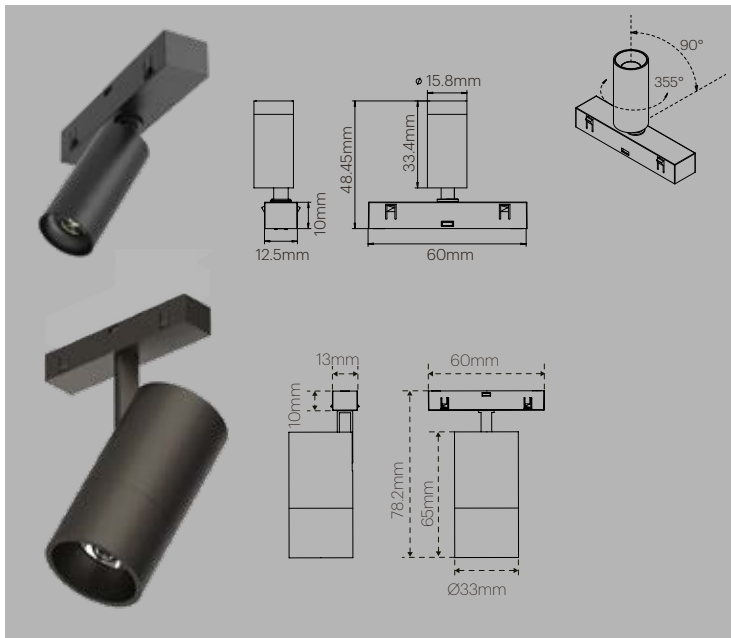

Avior A

			24V		
Item Code	Beam Angle	Wattage	Lumen	Kelvin	Finish
1226030	15°, 24°, *36°, *42°	1.5W	95lm	3000K	Black
1226035				3500K	
1226040				4000K	

*Beam Angle 36° and 42° available by special order.

Add -15, 24, 36, or 42 to item code for desired beam angle.

Avior A Plus

			24V		
Item Code	Beam Angle	Wattage	Lumen	Kelvin	Finish
538300019	15°, *24°, *36°	4.2W	290lm	3000K	Black
538300020				3500K	
538300021				4000K	

*Beam Angle 24° and 36° available by special order.

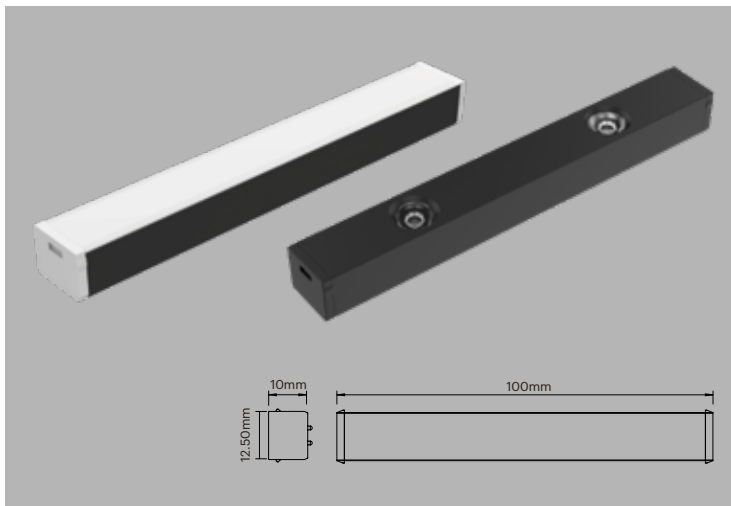

Avior D

			24V		
Item Code	Beam Angle	Wattage	Lumen	Kelvin	Finish
1226135	120°	2.6W	110lm	3500K	Black
1226140				4000K	

*3000K available by special order.

Avior L

			24V		
Item Code	Beam Angle	Wattage	Lumen	Kelvin	Finish
538900001	15°	3.5W	190lm	3000K	Black
538900003				4000K	
538900004	24°			3000K	
538900006				4000K	

*Additional BAs and CCTs available by special order.

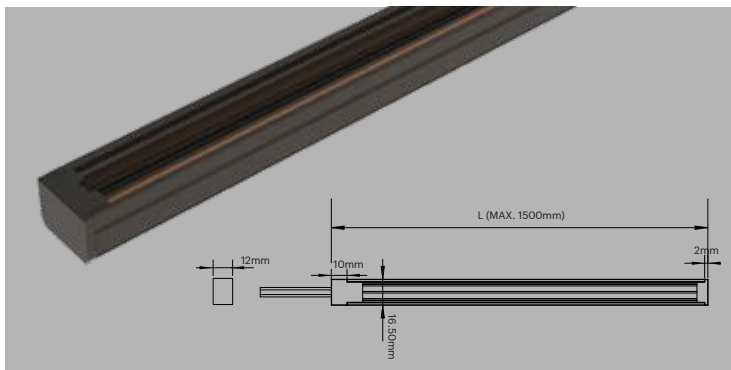

Avior Track

			24V		
Item Code	L (mm)	L (ft.)	H (mm)	H (ft.)	Finish
1226000*	max. 1500mm	4.9ft.	16.5mm	0.05ft.	Black

*Custom length will be added to production order as requested.
NOTE: End cap and input connection cable included with track.

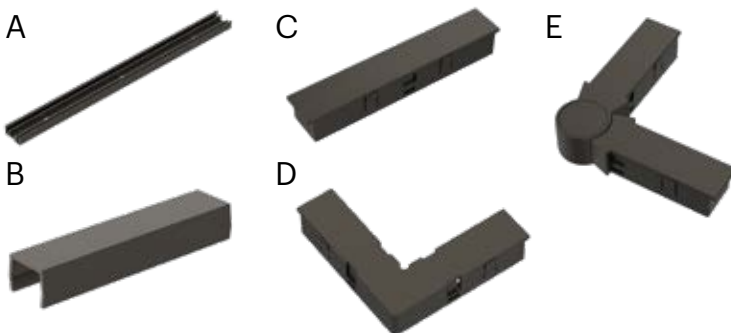

Avior Track Accessories

Item Code	Details	Length	Finish
1226001	A - Fixing bracket		Black
1226002	B - Track cover	62.5mm (2.5")	
1226003	C - Linear extension	72mm (2.8")	
1226005	D - Corner extension	49mm (1.9")	
1226006	E - Flexible corner extension	56mm (2.2")	

Special order lead time 4 weeks + shipping for this product. Please contact your sales representative for details.

Power Supplies & Control Systems



POWER
SUPPLIES &
MODULES



118
MEC DRIVER



122
SMART
MODULES

SMART
CONTROLLERS &
SENSORS



125
SMART
CONTROLLER



126
TOUCH
SWITCHES



127
WIRELESS
IR/PIR
SENSORS



127
WIRED IR/PIR
SENSORS

SWITCHES



128
TOGGLE
SWITCH

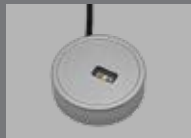

128
EMOTION
TOUCH SWITCH

ADDITIONAL
DRIVERS



129
350MA
DRIVER



129
DIMMABLE
DRIVER

MEC DRIVER SYSTEM

4 POWER SOURCES IN 1, WITH INTEGRATED CONTROL SYSTEMS.

Experience unparalleled versatility with our patented 4-in-1 power source, featuring integrated control systems for ultimate flexibility. Certified for nearly all global markets, the MEC Driver System is designed for limitless customization. Its modular design allows easy integration of lighting and smart controls - enabling intuitive, remote operation to connect your future effortlessly.

Product Characteristics

- Compact, low-profile driver ideal for tight spaces
- Multi Voltage Input 100/240VAC
- Globally certified
- Operates on 12V and 24V
- Power Cord 1.8m (6ft.) included
- Connect multiple drivers up to 500W with optional Daisy Chain Module
- Connect with Smart Modules to control lights via Bluetooth, Smart Home controls, remote control, voice, or sensor activated



MULTIVOLTAGE
Input: 100\240V AC Output: 12\24V DC



OPERATES ON BOTH 12VDC AND 24VDC



GLOBALLY CERTIFIED





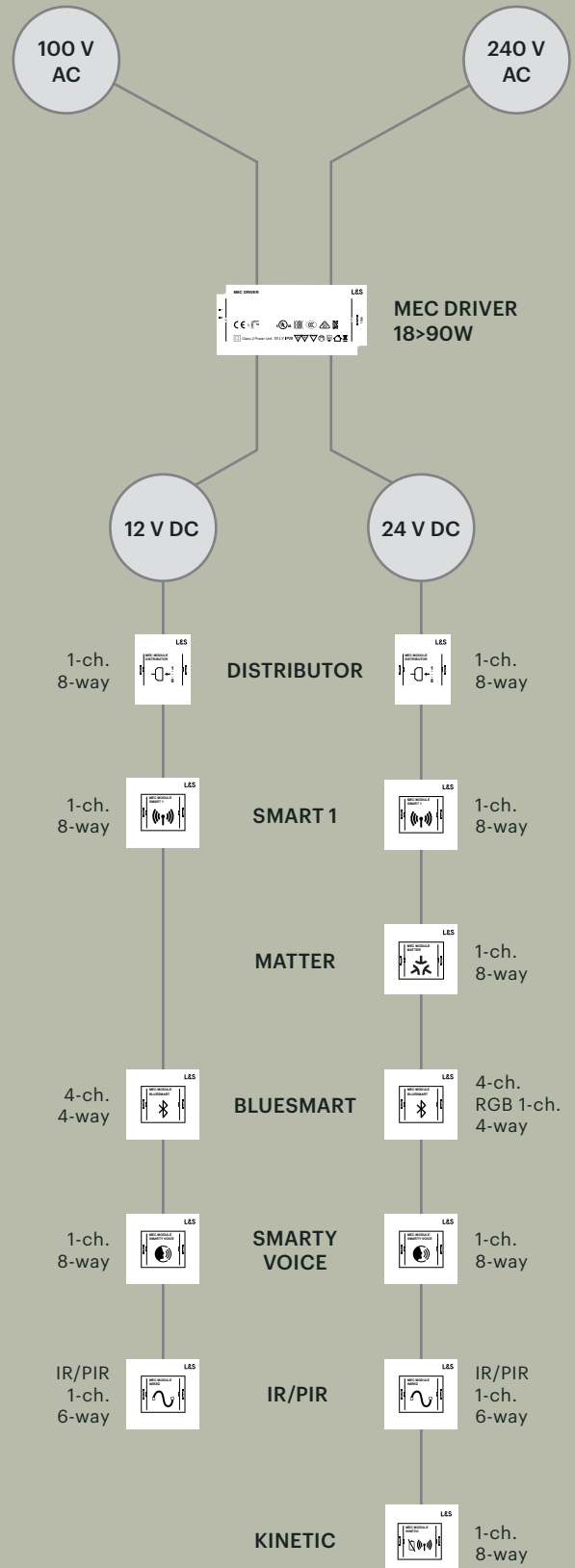

SMART CONTROL SYSTEM
Wi-Fi, Radio Frequency (R.F.), Bluetooth, Zigbee, Matter, Sensor



MEC Driver & Modules



MEC Driver & Modules



Output	Number of Outlets	Light Technology	Compatibility
 		 	

Power supply

Power Supply • 12 and 24 Vdc • Globally certified • Only 16 mm thick • Power cable included		18 W	12 V	24 V			 Input 100-240 V AC
		36 W	12 V	24 V			
		48 W	12 V	24 V			
		60 W	12 V				
		72 W		24 V			
		90 W		24 V			





Daisy Chain Module • Connect multiple MEC drivers, using only one outlet • Up to 500W		up to 500 W	12 V	24 V			
--	---	-------------	------	------	--	--	--









Distribution







Distributor • Light connection with or without on-board controller	 	Y-cable	12 V	24 V	2	Emotion	
		Module	12 V	24 V	8	Emotion	





Control





Smart 1 • Remote control • Wireless		Emotion	12 V	24 V	8	Emotion	  
--	---	---------	------	------	---	---------	---

Matter • Smart Home via Matter • Wi-Fi • Wireless / Remote Control		Emotion		24 V	8	Emotion	   
--	---	---------	--	------	---	---------	--

BlueSmart • Remote control • Bluetooth • Wireless		Emotion	12 V	24 V	4 individual channels	Emotion	   
		RGB		24 V	1	RGB	   

Smarty Voice • Remote control • Wi-Fi Voice control • Wireless		Emotion	12 V	24 V	8	Emotion	    
--	---	---------	------	------	---	---------	---

IR/PIR • Wireless IR/PIR sensors • Wired IR/PIR sensors		IR	12 V	24 V	6		 
		PIR	12 V	24 V	6		 

Kinetic • Piezoelectric technology • Wireless wall switch		Emotion		24 V	8	Emotion	  
--	---	---------	--	------	---	---------	---

MEC DRIVER CONFIGURATIONS

Standard Setup

MEC DRIVER + DISTRIBUTOR MODULE

The simple way to connect your lights - use the distributor module, plugged into the MEC Driver to connect up to 8 lights.



Advanced Setup

MEC DRIVER + SMART MODULE

Choose one of the L&S Smart Modules to control the lights via smart controller, sensor, app or smart device, such as Amazon Alexa or Google Home. Simply plug the module into the MEC Driver.

Smart Modules sold separately.

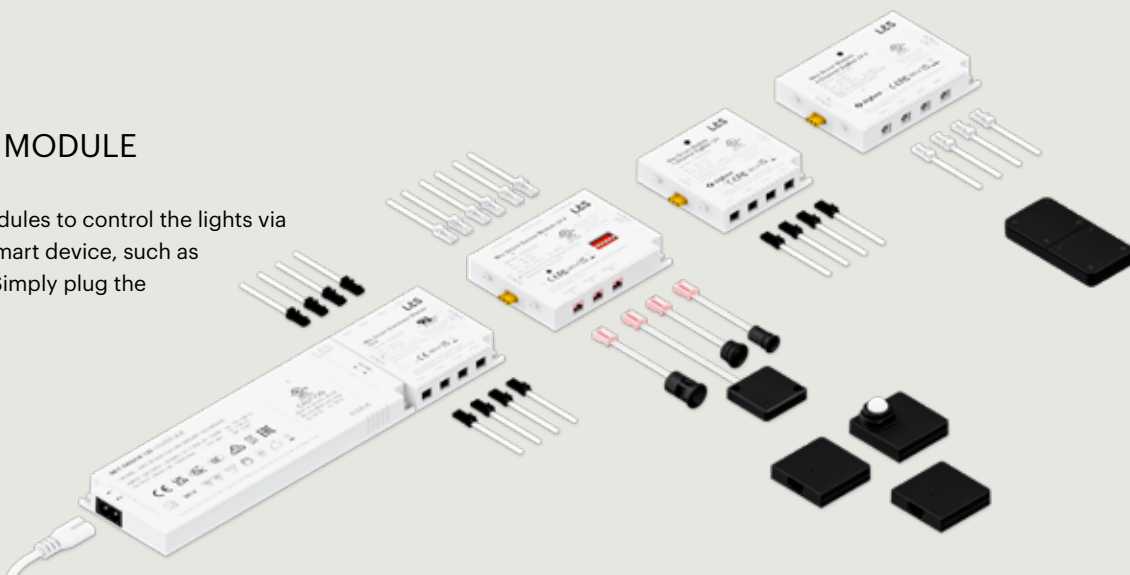

Daisy Chain Module & Y-cable Distributor

CONNECT MULTIPLE DRIVERS

The Daisy Chain Module is ideal for scenarios that require multiple MEC Drivers, when with limited power outlets are available. Link multiple drivers together, up to 500W.

Use the Y-cable if only up to two light connections are needed.

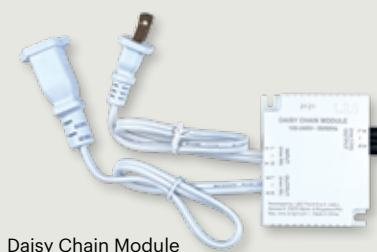

Daisy Chain Module

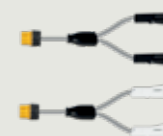

Y-cable Distributor

MEC DRIVER CONFIGURATIONS

MEC Driver w. Distributor

12V / 24V

Item Code*	Size (mm)	Size (inch)	Vdc	Wattage
1001218	170 x 75 x 16 mm	6.7 x 3 x 0.6"	12V	18W
1001236	220 x 75 x 16 mm	8.7 x 3 x 0.6"		36W
1001248	220 x 75 x 16 mm	8.7 x 3 x 0.6"		48W
1001260	270 x 75 x 16 mm	10.6 x 3 x 0.6"		60W
1002418	170 x 75 x 16 mm	6.7 x 3 x 0.6"	24V	18W
1002436	220 x 75 x 16 mm	8.7 x 3 x 0.6"		36W
1002448	220 x 75 x 16 mm	8.7 x 3 x 0.6"		48W
1002472	270 x 75 x 16 mm	10.6 x 3 x 0.6"		72W
1002490	270 x 75 x 16 mm	10.6 x 3 x 0.6"		90W

*Includes Distributor Module.



36W MEC Driver

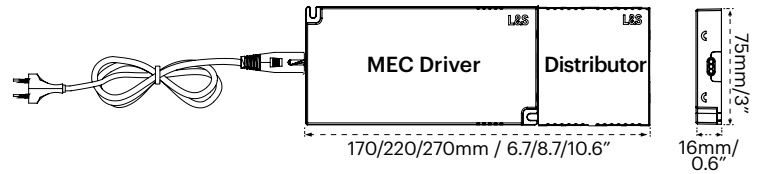

MEC Driver for Smart Module*

12V / 24V

Item Code	Size (mm)	Size (inch)	Vdc	Wattage
1000018	110 x 75 x 16 mm	4.3 x 3 x 0.6"	12V/24V	18W
1000036	160 x 75 x 16 mm	6.3 x 3 x 0.6"	12V/24V	36W
1000048	160 x 75 x 16 mm	6.3 x 3 x 0.6"	12V/24V	48W
1000067	210 x 75 x 16 mm	8.3 x 3 x 0.6"	12V	60W
			24V	72W
1000090	210 x 75 x 16 mm	8.3 x 3 x 0.6"	24V	90W

*Smart Modules to be purchased separately. No distributor needed if a Smart Module is used.



Smart Module

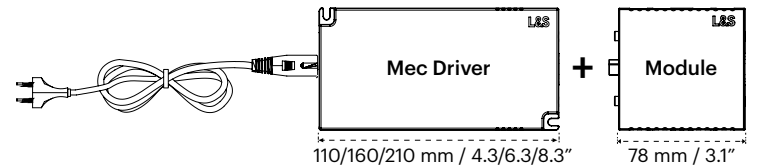

Accessories

Item Code	Accessories
1010245	Daisy Chain Module (see page 120 for details) (connect up to 500W MEC Drivers)
1500033	Extension Cord 120V (2m / 7ft.)
1500133	Extension Cord 120V (610mm / 2ft.)
9150037	Y-cable Distributor

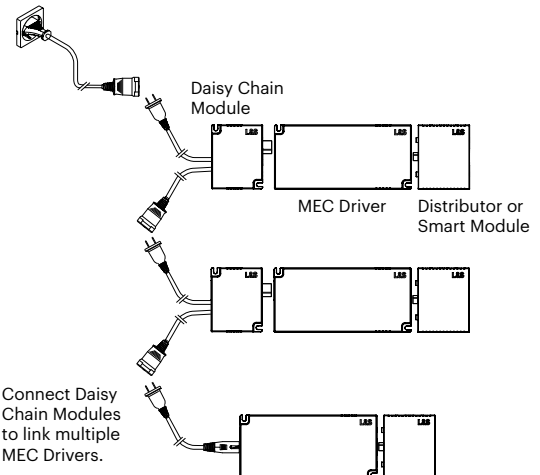

SMART MODULES

BlueSmart Module

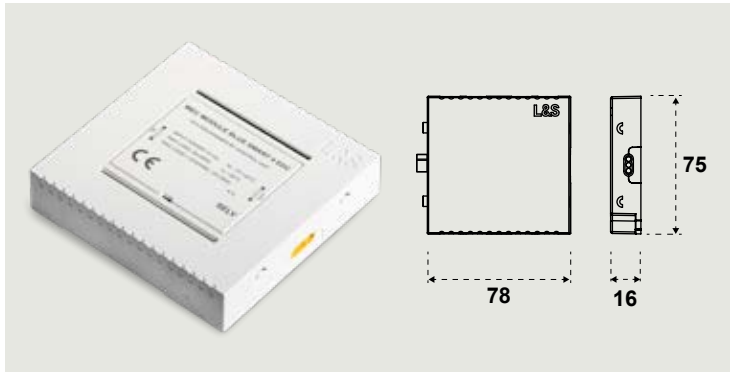

The BlueSmart module allows individual control of up to 4 lights via the BlueSmart app, available for iOS and Android. The module is also compatible with L&S smart controllers. Available in 12V or 24V versions, the modules can be connected to other distribution or control modules as long as the same output voltage is maintained.

BlueSmart Module

12V / 24V

Item Code	Version	Outlets	Vdc	Details
1601201	Emotion	4	12V	Module: max 5A total, 3A/port
1602401			24V	
1602402-01*	RGB	1		
1602402-02*	RGBW			

*Includes required RGB Adapter.

For additional ports please see distribution blocks on page 133.

Smart Controllers & Sensors

Item Code	Controller	Version	Channel	
1602007	Smart 1 Controller	Emotion	1 ch	
1602012	Smart 1 Controller	RGB	1 ch	
1602003	Smart 4	Emotion	4 ch	
1602006	Smart 4 Round	Emotion	4 ch	
1602004	Smart 4 Controller	RGB	4 ch	
1602005	Smart Touch	Touch Sensor	1 ch	
1602009	Smart Sensor O	PIR/Touch Sensor	1 ch	

Each controller and sensor in the Smart line can control up to 6 modules.

COMING SOON! Matter Module

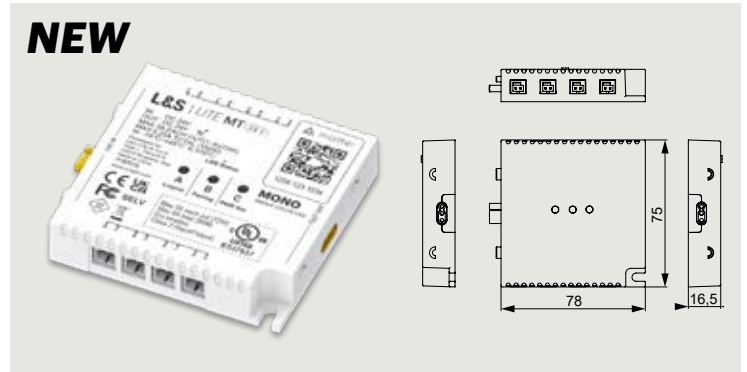

The new Matter module uses the Matter protocol, the universal standard for smart home devices. Easily connect between smart devices from different brands. Compatible with apps like Amazon Alexa, Google Home, and Apple HomeKit, it enables intuitive lighting control via voice assistants, smartphones, or remote control.

Matter Module

12V / 24V

Item Code	Version	Outlets	Vdc	Channels	Details
756200645	Emotion	8	24V	1	Module: max 4A total, 3A/port

For additional ports please see distribution blocks on page 133.

Smart Controllers

Item Code	Controller	Version	Channel	Finish	
756200040	Smart Lite Controller	Emotion	4 ch	Black	
756200041				White	

Each controller and sensor in the Smart line can control up to 6 modules.

Scan Code for BlueSmart App!



iOS



Android

SMART MODULES

Smart 1 Module

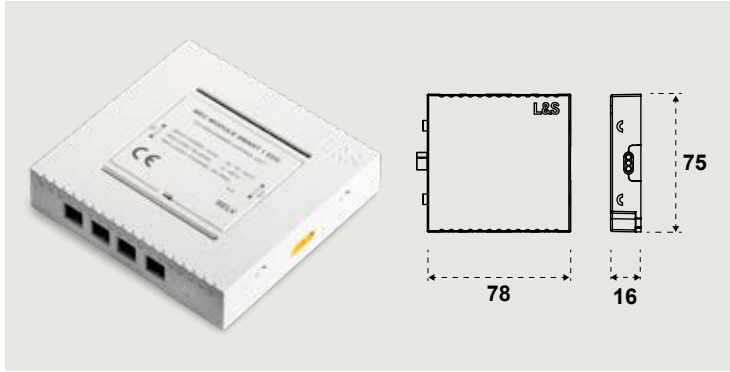

The Smart 1 module allows simultaneous control of up to 8 lights with a Smart Controller or Smart Sensor. Available in 12 V or 24 V versions, the module can be connected to other distribution or control modules as long as the same output voltage is maintained.

Smart 1 Module

12V / 24V

Item Code	Version	Outlets	Vdc	Details
1601203	Emotion	8	12V	Module: max 5A total, 3A/port
1602403			24V	

For additional ports please see distribution blocks on page 133.

Smarty Voice Module

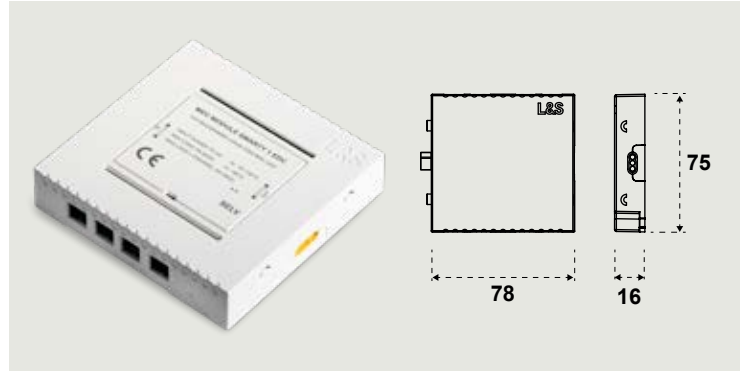

The Smarty Voice module easily controls your lights using voice commands with Google Home or Amazon Alexa, or create custom light schedules through the L&S app. Connect to a remote control for added convenience. Featuring 8 outlets, the module is available in both 12V and 24V versions.

Smarty Voice Module

12V / 24V

Item Code	Version	Outlets	Vdc	Details
1601207	Emotion	8	12V	Module: max 5A total, 3A/port
1602407			24V	

For additional ports please see distribution blocks on page 133.

Smart Controllers & Sensors

Item Code	Controller	Version	Channel	
1602007	Smart 1 Controller	Emotion	1 ch	
1602005	Smart Touch	Touch Sensor		
1602009	Smart Sensor O	PIR Sensor		

Each controller and sensor in the Smart line can control up to 6 modules.

Smart Controllers & Sensors

Item Code	Controller	Version	Channel	
1602007	Smart 1 Controller	Emotion	1 ch	
1602005	Smart Touch	Touch Sensor		
1602009	Smart Sensor O	PIR Sensor		

Each controller and sensor in the Smart line can control up to 6 modules.



Amazon Alexa and Google Home are registered trademarks of Amazon and Google.

Smarty Voice Module
instruction video!



SMART MODULES

Kinetic Module

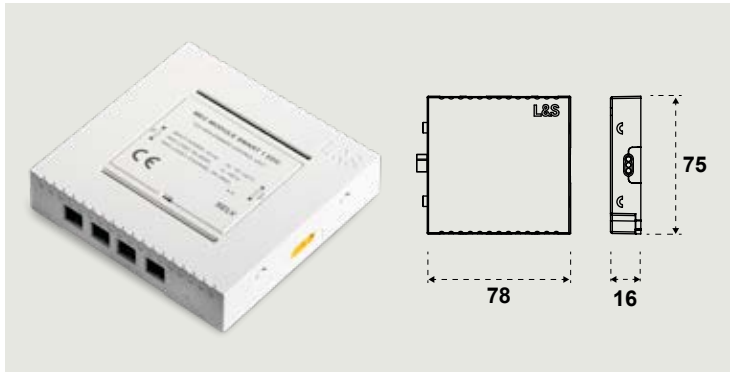

The Kinetic module allows simultaneous control of up to 8 lights with the dedicated remote control. Thanks to piezoelectric technology, the control works without a battery, avoiding any maintenance. Available at 24V, the modules can be connected to other distribution or control modules as long as the same output voltage is maintained.

Kinetic Module

24V

Item Code	Version	Outlets	Vdc	Details
1602408	Emotion	8	24V	Module: max 5A total, 3A/port

For additional ports please see distribution blocks on page 133.

Smart Controllers & Sensors

Item Code	Controller	Version	Channel	
1602409	Kinetic Controller	Emotion	1 ch	

Each controller and sensor in the Smart line can control up to 6 modules.

IR/PIR Module

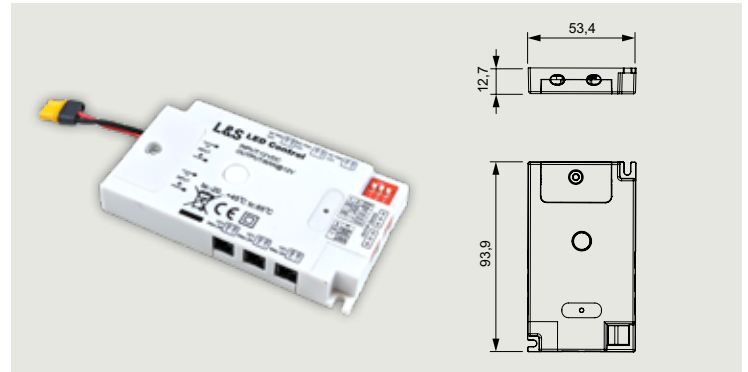

The IR/PIR module allows simultaneous control of up to 6 lights with the wireless Door Contact and Motion Sensor as well as the IR/PIR wired sensors. Available in 12V or 24V versions, the modules can be connected to other distribution or control modules as long as the same output voltage is maintained.

IR/PIR Module

12V / 24V

Item Code	Version	Outlets	Vdc	Details
1602015	IR/PIR	6	12V	Module: max 5A total, 3A/port
1602016			24V	

NOTE: IR/PIR Module can connect with up to 4 wireless sensors (see sensor options below)

For additional ports please see distribution blocks on page 133.

Smart Controllers & Sensors

Item Code	Controller	Version	Channel	
1602017	Door Contact Sensor - White	Wireless	1 ch	
1602019	Door Contact Sensor - Black			
1602018	Motion Sensor - White			
1602020	Motion Sensor - Black			
1602014	Wired IR Sensor	Wired	1 ch	
1602013	Wired PIR Sensor			

NOTE: Wireless sensors can connect with up to 3 IR/PIR Modules.

Each controller and sensor in the Smart line can control up to 6 modules.

SMART CONTROLLERS & SENSORS

1 Channel Controller - Emotion/RGB

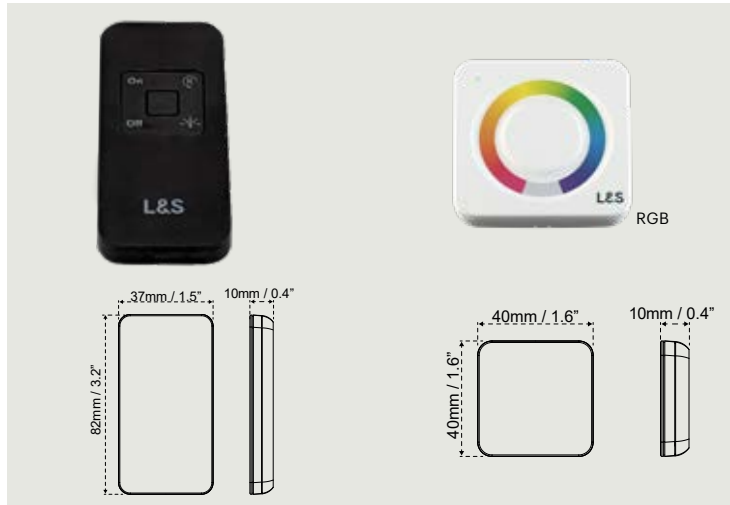

Connected to the Smart 1 Module, it controls the lights both for dimming the light intensity and for changing the color temperature in the Emotion and RGB versions.

- On/Off, Dimming, color temperature control
- 20m (66ft.) range indoor
- Battery required (included)

Item Code	Version	Channels	Finish
1602007	Emotion	1 ch	Black
1602012	RGB		White

4 Channel Controller - Emotion/RGB

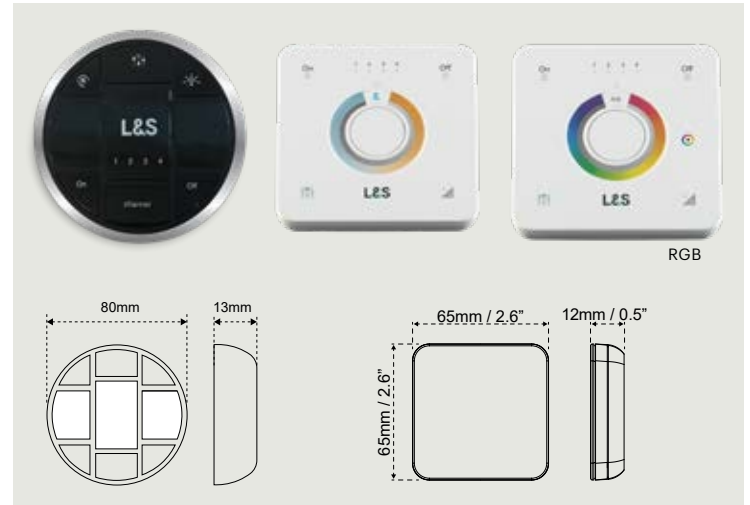

Wireless controller with buttons, touch controls and with the option to control and store up to 4 independent channels. Connected to the Smart 4 or BlueSmart Module, it controls the lights both for dimming the light intensity and changing the color temperature in the Emotion and RGB versions. Round controller includes magnetic mounting.

- On/Off, Dimming, color temperature control
- 20m (66ft.) range indoor
- Battery required (included)

Item Code	Version	Channels	Finish
1602003	Emotion	4 ch	White
1602006	Emotion Round		Black
1602004	RGB		White

Smart Controller instruction video!



SMART CONTROLLERS & SENSORS

NEW! 4 Ch. LITE Smart Controller

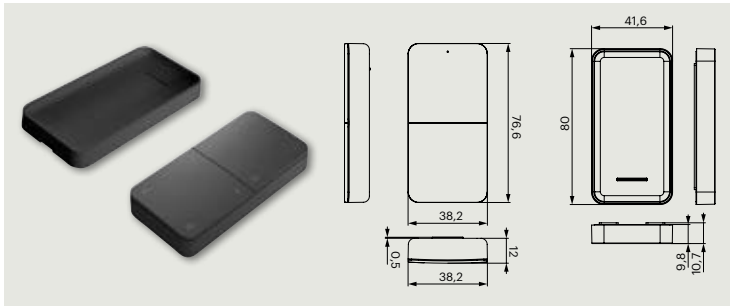

Easily manage up to 4 individual channels with the LITE Smart Controller, featuring dimming and color temperature control. Includes a convenient magnetic wall mount for easy installation. Capable of controlling lights connected to up to 6 Smart modules.

- Compatible with BlueSmart and Matter Modules
- 20m (66ft.) range indoor
- Battery required (included)

Item Code	Version	Channels	Finish
756200040	Emotion	4 ch	Black
756200041			White

Kinetic Controller

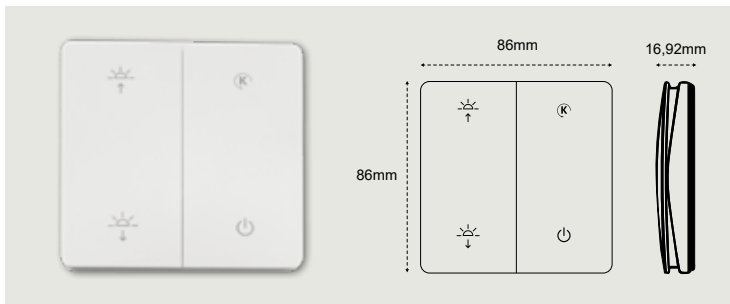

- Wall switch (wall mounting kit included)
- On/Off, Dimming, color temperature control
- 20m (66ft.) range indoor
- No battery required

Item Code	Version	Channels	Finish
1602409	Kinetic	1 ch	White

Smart Touch Controller

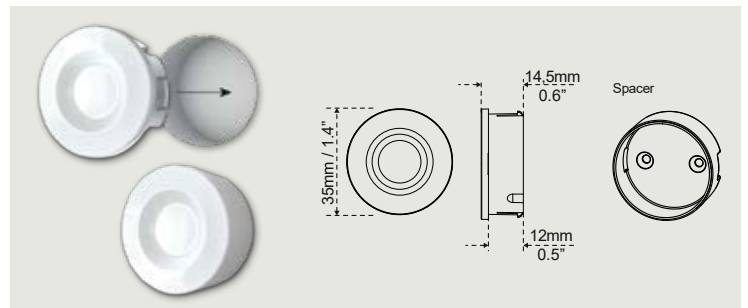

- Wireless touch controller
- Compatible with BlueSmart and Smart 1 Modules
- On/Off, Dimming, color temperature control
- 15m (49ft.) range indoor
- Battery required (included)

Item Code	Version	Finish
1602005	Touch Sensor	White

Smart Touch/Sensor Controller

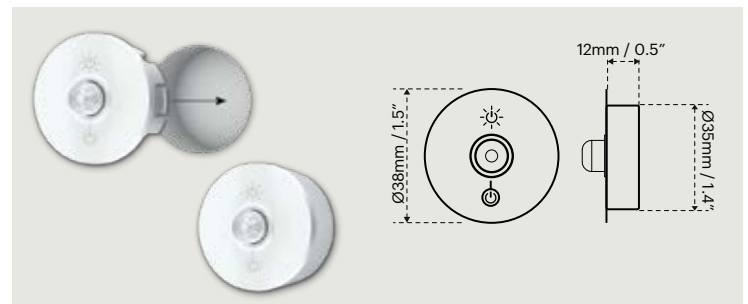

Switch between wireless touch and motion sensor with this 2-in-1 smart sensor. Set a threshold for motion detection or regulate light directly via touch control. The Smart Sensor O can change the light intensity and color temperature.

- Compatible with BlueSmart and Smart 1 Modules
- On/Off, Dimming, color temperature control
- 15m (49ft.) range indoor
- Battery required (included)

Item Code	Version	Finish
1602009	PIR Sensor	White

SMART CONTROLLERS & SENSORS

Door Contact Sensor

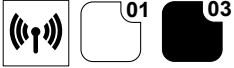

- Wireless IR Sensor
- Light switches on/off when door opens/closes
- Can be surfaced mounted or recessed
- Sensor response: 1-50mm (1/32-2")
- Battery required (included)

Item Code	Version	Channels	Finish
1602017	IR Sensor	1 ch	White
1602019			Black

NOTE: Wireless sensors can connect with up to 3 IR/PIR Modules.
Each controller and sensor in the Smart line can control up to 6 modules.

Motion Sensor



- Wireless motion sensor
- Light switches on/off when motion detected
- Angle range approx. 80°
- Max. range 3m (10ft.)
- Can be surfaced mounted or recessed
- Battery required (included)

Item Code	Version	Channels	Finish
1602018	PIR Sensor	1 ch	White
1602020			Black

NOTE: Wireless sensors can connect with up to 3 IR/PIR Modules.
Each controller and sensor in the Smart line can control up to 6 modules.

IR Sensor / Switch

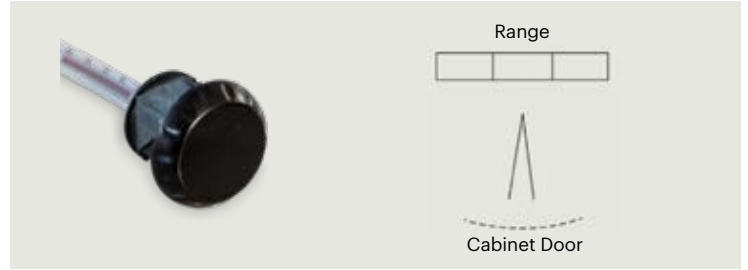

- Wired door contact sensor
- Choose between two modes (door sensor and switch mode)
- Door mode: Sensor reacts to door opens or closes
- Switch mode: Sensor acts as a switch and reacts to close hand motion
- Comes with 1.5m (5ft.) connection cable

Item Code	Version	Channels	Finish
1602014	IR Sensor	Ø 17.5mm (0.7"), Drill dimension: Ø 14mm (0.55") 1500mm (5ft.) cord attached	Black

PIR Sensor

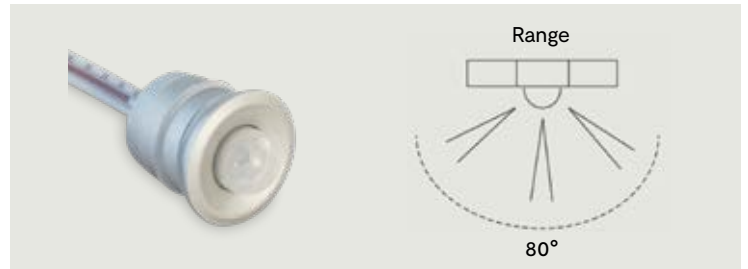

- Wired motion sensor
- Light switches on/off when motion detected
- Possible to change the switch-off time (15 seconds to 1 hr)
- Comes with 1.5m (5ft.) connection cable
- Max. range 3m (10ft.)

Item Code	Version	Details	Finish
1602013	PIR Sensor	Ø 20.5mm (0.8"), Drill dimension: Ø 17mm (0.67") 1500mm (5ft.) cord attached	White

SWITCHES (no Smart Module required)

Toggle Switch

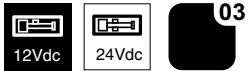
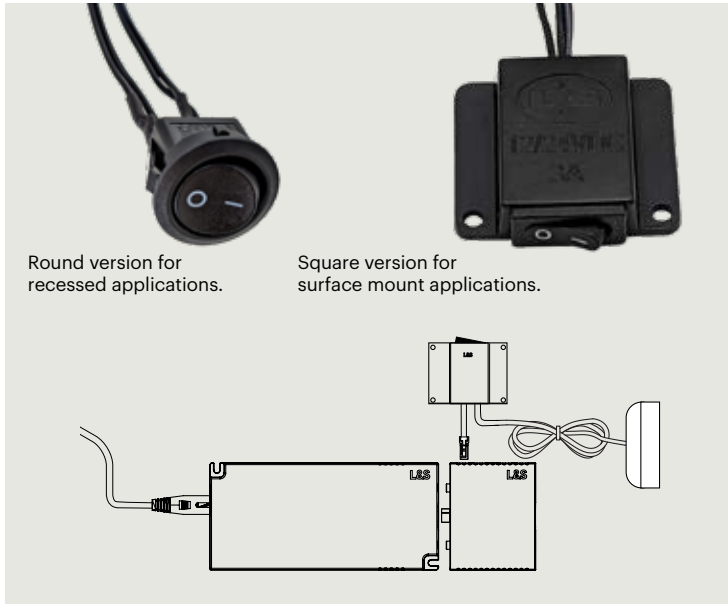

The economical On/Off Toggle Switch is a low cost, simple solution with Plug and Play connections. Available for recessed and surface mount applications. Includes a 10 port distribution block. Compatible with our MEC Driver and Standard Drivers.

Item Code	Version	Details	Finish
1600022	Square - 12V / 36W Max	includes 10 port mini distributor	Black
1600047	Square - 24V / 72W Max		
On request	Round - 12V		
1600029	Round - 24V		

Emotion Touch Switch

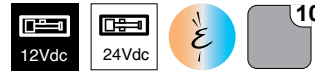
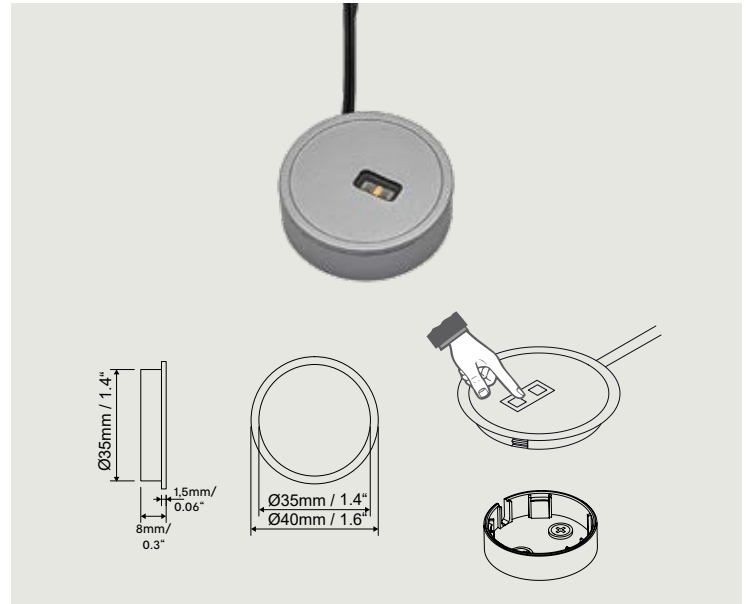

Control on/off, dimming and color temperature (Emotion) via touch control. The memory function saves the last setting. Can be recessed or surface mounted. Comes with a surface mounting ring and 10 port distribution block. Compatible with the L&S MEC Driver and other Standard Drivers.

Item Code	Version	Details	Finish
1649440	12V / 36W Max	includes 10 port mini distributor	Gray
1600024	24V / 72W Max		

ADDITIONAL DRIVER OPTIONS

350mA Driver

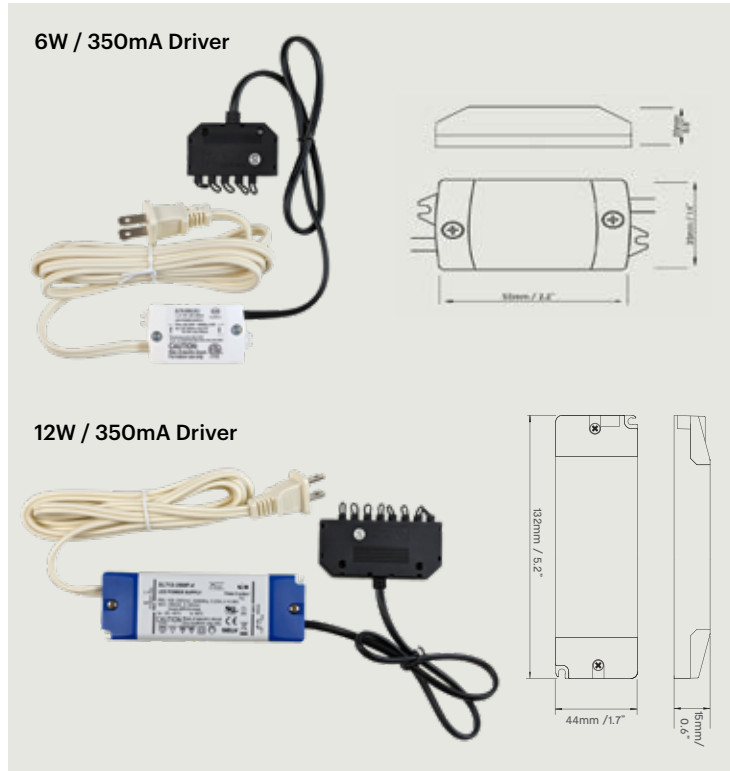

Product Characteristics

- Available in 6W and 12W
- Comes with attached LED mini distributor which allows plug&play connections for multiple fixtures
- Built in overload and overheat protection
- Attached connection cord: 2m (7ft.)
- Primary voltage: 110-120V
- Secondary: 350mA constant current

350mA Driver

Item Code	Wattage	Details
1012526	6W	includes 6 port mini distributor (max 6W of LEDs)
1012527	12W	includes 12 port mini distributor (max 12W of LEDs)

Dimmable Driver

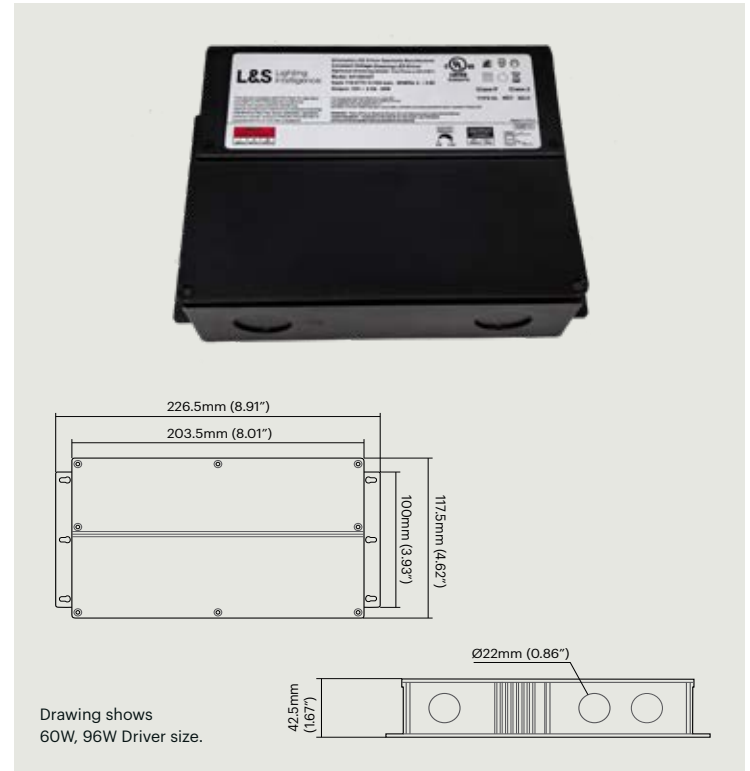

Product Characteristics

- Dimmable with any standard TRIAC dimmer switches
- Includes 10 port distribution block
- Class 2 rated
- Built in active PFC, typical power factor>0.95, THD<10% at 120V max. load
- Load: 0.01-100%
- Short-circuit, over-temperature, over-load protection
- Input Voltage: 110-277V / Output voltage: 12V/24V
- Efficiency up to 80%
- Flicker-free
- Full protection metal case for dry, damp, or wet location (IP65)
- Wall Plug must be hard wired on-site

Dimmable Driver

12V

Item Code	Wattage	Dimensions	Details
941500397	30W	170.5x116x42mm (6.7x4.6x1.7")	includes 10 port Mini Distribution Block
941500399	60W	226.5x117.5x42mm (8.9x4.6x1.7")	

Dimmable Driver

24V

Item Code	Wattage	Dimensions	Details
941500398	30W	170.5x116x42mm (6.7x4.6x1.7")	includes 10 port Mini Distribution Block
941500400	60W	226.5x117.5x42mm (8.9x4.6x1.7")	
941500401	96W		

Accessories



QI CHARGER



132

QI CHARGER

USB CHARGER



132

USB
CHARGER

OTHER
ACCESSORIES



133

EXTENSION
CORDS



133

DISTRIBUTION
BLOCKS

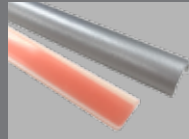

133

CABLE
CHANNELS



133

CONNECTION
CABLES

ACCESSORIES

Qi Charger



EASY WIRELESS CELL PHONE CHARGING

The Qi Wireless Charger easily charges smart phones and tablets with induction batteries. The device can be recessed into furniture or installed underneath the surface for invisible charging.

Product Characteristics

- 12V, 5W output, compatible with MEC Driver (max. 3 devices per 18W Mec Driver)
- Available in two versions: hidden, recessed
- Can be recessed in a 68mm hole with a construction height of only 10mm; Hidden version can withstand a material thickness up to 3mm
- Includes 1800mm (6ft.) connection cord
- Suitable for mounting in furniture, under cabinets or shelves
- Smartphones with Qi support: www.qi-wireless-charging.net



Qi Charger

Qi Charger		12V		
Item Code	Version	Wattage	DIA (hole)	Finish
1649140	Recessed (visible)	5W	68mm (2.7")	Gray
1649141	Hidden (underneath surface)			Black

Dimensions & Installation

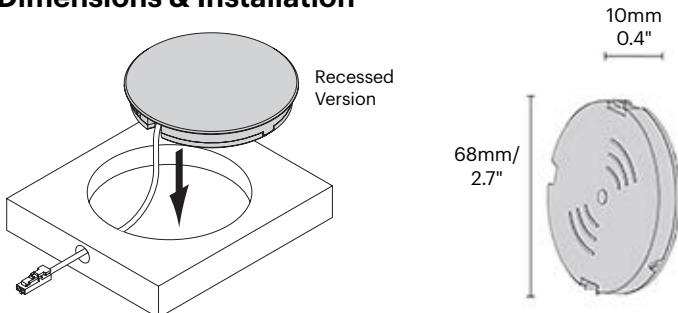

USB Charger



2 PORT USB CHARGER

Versatile USB charger that can be mounted virtually anywhere - cabinets, counters or walls to charge any wireless device.

Product Characteristics

- 12V, max output 1x2,1A or 2x1,05A
- Compatible with MEC Driver
- Can be mounted in or under cabinets, on countertops, desktops, shelves or bedside tables
- For charging of wireless devices using a standard USB cord



USB Charger

USB Charger			12V	
Item Code	Wattage	Dimensions (Charger)	Dimensions (Recess)	Finish
2300015	12W	37mm x 37mm / 1.5" x 1.5"	35 x 35mm / 1.4" x 1.4"	Black
2300004			Gray	

Dimensions

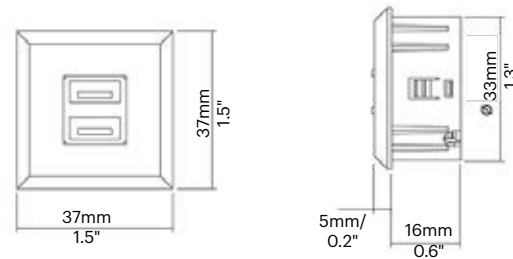

ADDITIONAL ACCESSORIES

Extension Cords

- Extension cord from driver to fixture or fixture to fixture
- Black 12V, white 24V



Extension Cords

Item Code	Version	Length (mm)	Length (ft.)
1540601	Black: 12V 20 AWG UL Style 20276	250mm	1ft.
1540701		500mm	2ft.
1540801		1000mm	3ft.
1540901		2000mm	7ft.
1540602	White: 24V 20 AWG UL Style 20276	250mm	1ft.
1540702		500mm	2ft.
1540802		1000mm	3ft.
1540902		2000mm	7ft.



Distribution Block

- Up to 10 lights
- Black 12V, white 24V



Distribution Block

12V / 24V

Item Code	Version	L (mm)	L (ft.)
1500005	Black: 12V	170mm	0.6ft.
1500006	White: 24V		

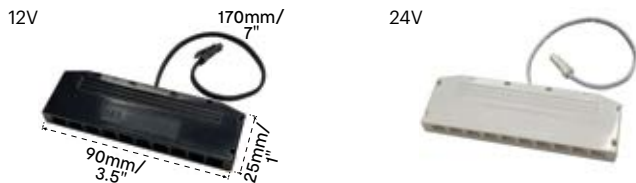

Cable Channels

- Hide cables in visible areas
- Curved channel snaps or slides onto adhesive backing
- Easy to cut to fit

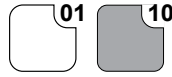

Cable Channels

Item Code	L (mm)	L (ft.)	Finish
1406201	1200mm	4ft.	White
1406265			Gray

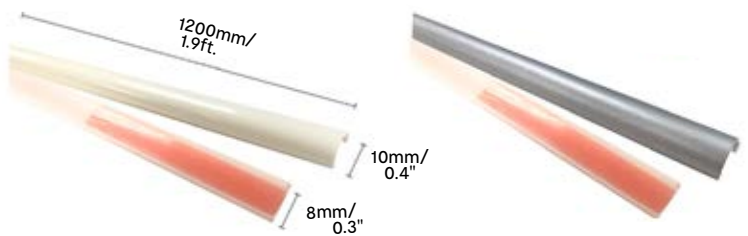

Connection Cables

12V / 24V

Item Code	Details	Vdc	Use
9150047	A - Y Cable for MEC Driver	12V	Driver to two outlets
9150037		24V	
9150048	B - 1-1 Cable for MEC Driver	12V	Driver to one outlet
9150049		24V	
9150050	C - Extension Cable for MEC Driver	12V	Driver to Module ext.
9150051		24V	
9305525	D - 4 Way Barrel Splitter 24V Male Input, 4 Female Output	24V	Four outlets light connection
1541001	E - Extension Cable Barrel Plug	12/24V	For light connection
1500024	F - Connection Cord MEC Driver to Female Barrel Plug	24V	Driver to one outlet

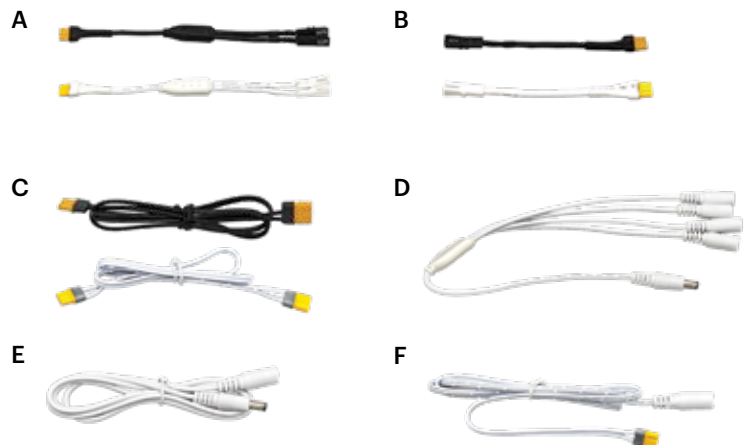

Terminology & Symbols

CORRELATED COLOR TEMPERATURE (CCT)

A specification of colored light emitted by a lamp typically measured in Kelvin (K). Generally, this is referred to as the warmth or coolness of the lamp. Ratings of 3500K and below are typically “warm” and ratings above 3500K are typically “cool”.

KELVIN (K)

Color temperature is based on the principle that a black body radiator emits light whose color depends on the temperature of the radiator. Black bodies with temperatures ranging from 2500K-3500K are considered warm white and populate the red/orange spectrum. 3500K-4500K are considered neutral or natural white and 4500K-6500K are typically cool whites in the blue spectrum.

COLOR RENDERING INDEX (CRI)

A measured number that rates a lamp’s ability to accurately render colors in the way that they are meant to be seen. Typically, a higher number indicates a better quality of light that closely resembles light from the sun.

EFFICACY

A simple formula for measuring efficiency and effectiveness. It is easy as Lumens (lm) per Watt (W). Think in terms of Miles per Gallon (MPG). If Lumens are produced from a 100W lamp, $1000\text{Lm}/100\text{W} = 10\text{Lm}/\text{W}$.

BEAM ANGLE

The measurement of the cone of light that is emitted from a lamp. It is measured from its furthest edges where the light falls to 50% of the candlepower from the center. The center is commonly referred to as nadir.

LUMENS (LM)

The unit of measurement of luminous flux used to indicate the quality or intensity of any lamp. Think of it in terms of the lamp’s raw power at the source. Lumens are measured at the lamp and not to be confused with Foot-candles or lux which are the measurement of luminosity at the surface.

LUX & FOOT-CANDLES

Measurements of light on a surface targeted for illumination. Lux is a unit of light and is defined by 1 square meter of light emitted by a standard wax candle 1 meter from an illuminated surface. Similarly, a foot-candle is the same definition with 1 square foot of light, 1 foot from the surface. Foot-candles are

generally an American measurement while Lux is typically European. $1\text{Fc}=10.764\text{Lux}$.

WATTAGE (W)

A unit of power denoting the rate at which electricity is used. One Watt is the rate at which work is done when one Ampere (A) of current flows through an electrical potential difference of one Volt (V). $W = V \times A$

VOLTAGE (VDC)

The “tension” between two ends of a path is the total energy required to move a small electric charge along that path, divided by the magnitude of the charge. Voltage is electric potential energy per unit charge, measured in joules per coulomb (= Volts). It is often referred to as “electric potential”.

EMOTION TECHNOLOGY

The Emotion technology allows the color temperature to change gradually from warm white (WW) to cold white (CW). Color temperatures have an important impact on how spaces are perceived and can be a critical element in the layout of a store or the interior design of a living space. Most L&S lighting is available in Emotion (2700K-6500K).

Source	Power supply	Symbols	Technology	Certifications
Warm white (~ 3000K)	12 V DC constant voltage	Cable length ~3m	Wireless connection	cULus
Natural white (~ 4000K)	24 V DC constant voltage	Dimmable	Wi-Fi	Intertek Testing Services
Cold white (~ 6000K)	350mA constant current	IP20 IP protection index	Bluetooth	The DesignLights Consortium®
RGB	100-240V- input	Cuttable	Audio/Voice Control	National Sanitation Foundation Certification
Emotion	USB	Daisy chain	Matter	
Blue Light Technology			IR switch	
			IR sensor for doors	
			PIR sensor for doors	

Finishes

Transparent	Black	Gray	Nickel
White	Chrome	Anodised Aluminum	Stainless Steel

PHOTOMETRICS

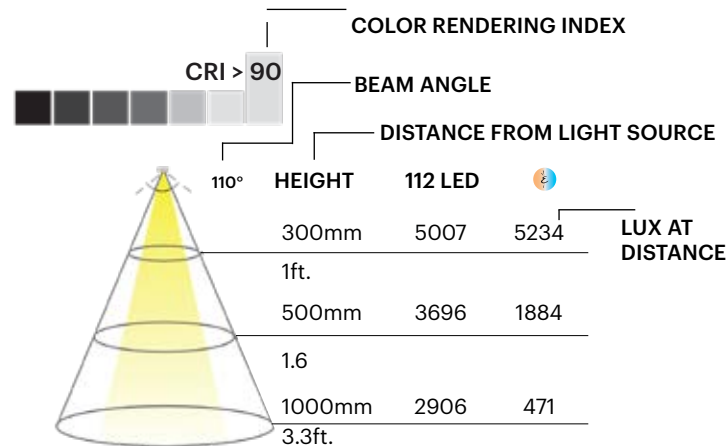

Lux values measured with illuminance meter in a simulated application environment.

INSULATION CLASSES

- Class 1**
Equipment is protected against electric shock by means of a protective ground being connected between the supply plug and conductive (metal parts) of the equipment. This is in addition to basic insulation.
- Class 2**
Double insulated appliances are protected against electric shock by basic insulation and additional safety precautions such as double insulated or reinforced insulation.
- Class 3**
Appliances are protected against electric shock on supply from a safety extra low voltage (SELV) source. SELV voltages will not exceed 50V and are typically below 12V/24V.

DIMENSIONAL DRAWINGS

All measurements are nominal.

SAFETY

All L&S products conform with current regulations regarding the safety, performance and the electromagnetic compatibility and auxiliary lighting components.

IP PROTECTION RATING

(Ingress Protection for particulates and moisture)
All L&S products are IP20 unless otherwise stated.

DIMMING

All L&S products are dimmable unless otherwise stated.

L&S LIGHTING CORPORATION

1505 Pavilion Place, Suite A | Norcross, GA 30093 | USA
Ph. +1 877 877 0757 | Fax. +1 770 800 7981 | info.us@
ls-light.com | www.ls-light.com

L&S